



75  
Azadi Ka  
Amrit Mahotsav

# SCIENCE TEXTBOOK

Veda Bhushan V Year / Purva Madhyama - II Year / Class X

**MAHARSHI SANDIPANI RASHTRIYA VEDA SANSKRIT SHIKSHA BOARD**  
(Established and Recognized by the Ministry of Education, Government of India)

पृथिव्याः सद्यस्थाद् अग्निं पुरीष्यम् अद्भ्यस्वत् खनामि।

ज्योतिष्मन्तं त्वाग्ने सुप्रतीकम् अजस्त्रेण भानुना दीद्यतम्॥

पुरीष्योसि विश्वभराऽअथवां त्वा प्रथमो निरमन्थदग्ने।

त्वामग्ने पुष्करादध्यथवां निरमन्थत भूर्गो विश्वस्य वाघतः ॥

सूर्यस्य विविधवर्णाः पवनेन विघटिताः कराः साग्ने ।

वियति धनुः संस्थाना ये दृश्यन्ते तदिन्द्रधनुः ॥

चक्षुरसि चक्षुर्मे दाः स्वाहा ।

अरण्योर्निहितो जातवेदा गर्भं इव सुधितो गर्भिणीषु।

दिवेदिव ईड्यो जागृवद्भिर्हविष्मद्भिर्मनुष्येभिरग्निः ॥

विश्वं पुष्टं ग्रामे अस्मिन् अनातुरम् ।

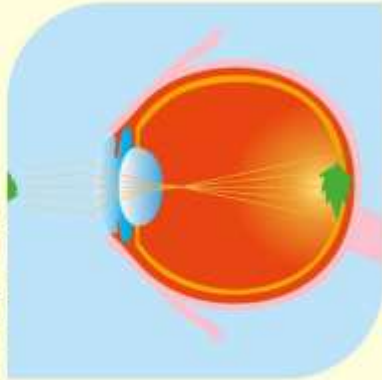
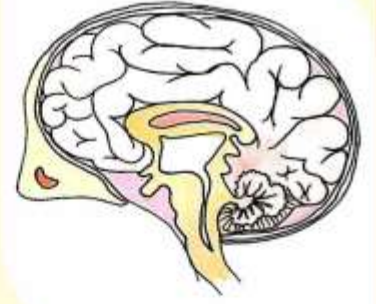
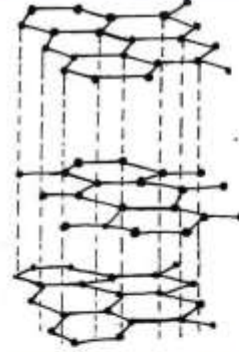
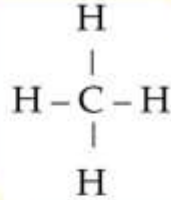

**MAHARSHI SANDIPANI RASHTRIYA VEDA VIDYA PRATISHTHAN, UJJAIN (M.P.)**  
(Ministry of Education, Government of India)

Phone : (0734) 2502266, 2502254, E-mail : msrvvpujn@gmail.com, website - www.msrvvp.ac.in

---

**Note :-**

Any Suggestion may be sent in email: [msrvvp.textbooks@gmail.com](mailto:msrvvp.textbooks@gmail.com), along with the proposed texts for replacement/addition/correction etc., and sender's identification details. The texts may be sent in Unicode font only.

# SCIENCE TEXTBOOK

Veda Bhushan V Year / Purva Madhyama - II Year / Class X

**MAHARSHI SANDIPANI RASHTRIYA VEDA SANSKRIT SHIKSHA BOARD**

(Established and Recognized by the Ministry of Education, Government of India)



**MAHARSHI SANDIPANI RASHTRIYA VEDA VIDYA PRATISHTHAN, UJJAIN (M.P.)**

(Ministry of Education, Government of India)

Veda Vidya Marg, Chintaman, Jawasiya, Ujjain, Madhya Pradesh 456006

Phone : (0734) 2502266, 2502254, E-mail : msrvvpunj@gmail.com, website - www.msrvvp.ac.in

Text book developed by :

Cover and decoration :

Drawing :

Technical Support :

Composed by :

Reviewers :

©Maharshi Sandipani Rashtriya Vedavidya Pratishthan, Ujjain ISBN :

Price :

Edition : 1<sup>st</sup> Edition.

Published Copies :

Paper usage : Printed on 80 GSM paper with RSTB Watermark

Publisher : Maharshi Sandipani Rashtriya Vedavidya  
Pratishthan (Under the Ministry of  
Education, Govt. of India) Vedavidya Marg,  
Chintaman Ganesh, Post Jawasiya, Ujjain  
(M.P.) 456006

email : [msrvvpujn@gmail.com](mailto:msrvvpujn@gmail.com),

Web : [msrvvp.ac.in](http://msrvvp.ac.in)

Phone : (0734) 2502255, 2502254

## PREFACE

(In the light of NEP 2020)

The Ministry of Education (Department of Higher Education), Government of India established Rashtriya Veda Vidya Pratishthan in Delhi under the Chairmanship of Hon'ble Education Minister ( then Minister of Human Resource Development) under the Societies Registration Act, 1860 (XXI of 1860) on 20th January, 1987. The Government of India notified the resolution in the Gazette of India vide no 6-3/85- SKT-IV dated 30-3-1987 for establishment of the Pratishthan for preservation, conservation, propagation and development of oral tradition of Vedic studies (Veda Samhita, Padapatha to Ghanapatha, Vedanga, Veda Bhashya etc), recitation and intonation of Vedas etc and interpretation of Vedas in scientific lines. In the year 1993 the name of the organization was changed to Maharshi Sandipani Rashtriya Veda Vidya Pratishthan (MSRVVP) and it was shifted to Ujjain, Madhya Pradesh.

The National Education Policy of 1986 and Revised Policy Formulations of 1992 and also Programme of Action (PoA) 1992 have mandated Rashtriya Veda Vidya Pratishthan for promoting Vedic education throughout the country. The importance of India's ancient fund of knowledge, oral tradition and employing traditional Guru's for oral education was also emphasized in the PoA.

In accordance with the aspirations of the nation, national consensus and policy in favour of establishing a Board for Veda and Sanskrit Education at national level, the General Body and the Governing Council of MSRVVP under the Chairmanship of Hon'ble Education Minister, Government of India, have set up "Maharshi Sandipani Rashtriya Veda Sanskrit Shiksha Board" (MSRVSSB) in tune with the mandate of the Pratishthan and its implementation strategies. The Board is necessary for the fulfillment of the objectives of MSRVVP as envisioned in the MoA and Rules. The Board has been approved by the Ministry of Education, Government of India and recognized by the Association of Indian

Universities, New Delhi. The bye-laws of the Board have been vetted by Central Board of Secondary Education and curriculum structure have been concurred by the National Council of Educational Research and Training, New Delhi.

It may also be mentioned here that the committee “Vision and Roadmap for the Development of Sanskrit - Ten year perspective Plan”, under the Chairmanship of Shri N. Gopaldaswamy, former CEC, constituted by the Ministry of Education Govt. of India in 2015 recommended for establishment of a Board of Examination for standardization, affiliation, examination, recognition, authentication of Veda Sanskrit education up to the secondary school level. The committee was of the opinion that the primary level of Vedic and Sanskrit studies should be inspiring, motivating and joyful. It is also desirable to include subjects of modern education into Vedic and Sanskrit Pathashalas in a balanced manner. The course content of these Pathashalas should be designed to suit to the needs of the contemporary society and also for finding solutions to modern problems by reinventing ancient knowledge.

With regard to Veda Pathashala-s it is felt that they need further standardization of recitation skills along with introduction of graded materials of Sanskrit and modern subjects so that the students can ultimately acquire the capabilities of studying Veda bhashya-s and mainstreaming of students is achieved for their further studies. Due emphasis may also be given for the study of Vikriti Patha of Vedas at an appropriate level. The members of the committee have also expressed their concern that the Vedic recitation studies are not uniformly spread all over India; therefore, due steps may be taken to improve the situation without in anyway interfering with regional variations of recitation styles and teaching method of Vedic recitation.

It was also felt that since Veda and Sanskrit are inseparable and complementary to each other and since the recognition and affiliation problems are same for all the Veda Pathashalas and Sanskrit Pathashalas throughout the country, a Board may be constituted for both together. The committee observed that the examinations conducted by the Board

should have legally valid recognition enjoying parity with modern Board system of education. The committee observed that the Maharshi Sandipani Rashtriya Veda Vidya Pratishthan, Ujjain may be given the status of Board of Examinations with the name “Maharshi Sandipani Rashtriya Veda Sanskrita Vidya Parishat with headquarters in Ujjain which will continue all programs and activities which were being conducted hitherto in addition to being a Board of Examinations.

The promotion of Vedic education is for a comprehensive study of India’s glorious knowledge tradition and encompasses multi-layered oral tradition of Vedic Studies (Veda Samhita, Padapatha to Ghanapatha, Vedanga, Veda Bhashya etc), recitation and intonation, and Sanskrit knowledge system content. In view of the policy of mainstreaming of traditional students and on the basis of national consensus among the policy making bodies focusing on Vedic education, the scheme of study of Veda stretching up to seven years in Pratishthan also entails study of various other modern subjects such as Sanskrit, English, Mathematics, Social Science, Science, Computer Science, Philosophy, Yoga, Vedic Agriculture, etc. as per the syllabus and availability of time. In view of NEP 2020, this scheme of study is with appropriate inputs of Vedic knowledge and drawing the parallels of modern knowledge in curriculum content focusing on Indian Knowledge System.

In Veda Pathashala-s, GSP Units and Gurukula-s of MSRVP, affiliated to the Board transact the curriculum primarily based on oral tradition of a particular complete Veda Shakha with perfect intonation and memorization, with additional subsidiary modern subjects such as English, Sanskrit, Mathematics, Science, Social Science and SUPW. Gradually, the Veda Pathashala-s will also introduce other skill and vocational subjects as per their resources.

It is a well-known fact that there were 1131 shakha-s or recensions of Vedas; namely 21 in Rigveda, 101 in Yajurveda, 1000 in Samaveda and 9 in Atharva Veda. In course of time, a large number of these shakhas became extinct and presently only 10 Shakhas, namely, one in Rigveda, 4

in Yajurveda, 3 in Samaveda and 2 in Atharvaveda are existing in recitation form on which Indian Knowledge System is founded now. Even in regard to these 10 Shakhas, there are very few representative Vedapathis who are continuing the oral Vedic tradition/ Veda recitation/Veda knowledge tradition in its pristine and complete form. Unless there is a full focus for Vedic learning as per oral tradition, the system will vanish in near future. These aspects of Oral Vedic studies are neither taught nor included in the syllabus of any modern system of school education, nor do the schools/Boards have the systemic expertise to incorporate and conduct them in the conventional modern schools.

The Vedic students who learn oral tradition/ recitation of Veda are there in their homes in remote villages, in serene and idyllic locations, in Veda Gurukulas, (GSP Units), in Veda Pathashala-s, in Vedic Ashrams etc. and their effort for Veda study stretches to around 1900 – 2100 hours per year; which is double the time of other conventional school Board's learning system. Vedic students have to have complete Veda by-heart and recite verbatim with intonation (*udatta, anudatta, swaritaetc*), on the strength of memory and guru parampara, without looking at any book/pothi. Because of unique ways of chanting the Veda mantras, unbroken oral transmission of Vedas and its practices, this has received the recognition in the UNESCO-World Oral Heritage in the list of Intangible Cultural Heritage of Humanity. Therefore, due emphasis is required to be given to maintain the pristine and complete integrity of the centuries old Vedic Education (oral tradition/ recitation/ Veda knowledge Tradition). Keeping this aspect in view the MSRVVP and the Board have adopted unique type of Veda curriculum with modern subjects like Sanskrit, English, Vernacular language, Mathematics, Social Science, Science, Computer Science, Philosophy, Yoga, Vedic Agriculture etc. as well as skill and vocational subjects as prescribed by NEP 2020.

As per Vedic philosophy, any person can become happy if he or she learns both *Para-Vidya and Aparā-Vidya*. The materialistic knowledge from the Vedas, their auxiliary branches and subjects of material interest were called *Aparā-Vidya*. The knowledge of supreme reality, the ultimate quest from Vedas, Upanishads is called *Para-Vidya*. In all the total



number of subjects to be studied as part of Veda and its auxiliaries are fourteen. There are fourteen branches of learning or *Vidyas* - four Vedas, Six Vedangas, Mimamsa (Purva Mimamsa and Uttara Mimamsa), Nyaya, Puranas and Dharma shastra. These fourteen along with Ayurveda, Dhanurveda, Gandharvaveda and Arthashastra become eighteen subjects for learning. All curriculum transaction was in Sanskrit language, as Sanskrit was the spoken language for a long time in this sub-continent.

Eighteen Shilpa-s or industrial and technical arts and crafts were mentioned with regard to the Shala at Takshashila. The following 18 skills/Vocational subjects are reported to be subjects of the study– (1) Vocal music (2) Instrumental music (3) Dancing (4) Painting (5) Mathematics (6) Accountancy (7) Engineering (8) Sculpture (9) Cattle breeding (10) Commerce (11) Medicine (12) Agriculture (13) Conveyancing and law (14) Administrative training (15) Archery and Military art (16) Magic (17) Snake charming (18) Art of finding hidden treasures.

For technical education in the above mentioned arts and crafts an apprenticeship system was developed in ancient India. As per the Upanishadic vision, the vidya and avidya make a person perfect to lead contented life here and liberation here-after.

Indian civilization has a strong tradition of learning of shastra-s, science and technology. Ancient India was a land of sages and seers as well as of scholars and scientists. Research has shown that India had been a Vishwa Guru, contributing to the field of learning (vidya-spiritual knowledge and avidya- materialistic knowledge) and learning centers like modern universities were set up. Many science and technology based advancements of that time, learning methodologies, theories and techniques discovered by the ancient sages have created and strengthened the fundamentals of our knowledge on many aspects, may it be on astronomy, physics, chemistry, mathematics, medicine, technology, phonetics, grammar etc. This needs to be essentially understood by every Indian to be proud citizen of this great country!

The idea of India like “Vasudhaiva Kutumbakam” quoted at the

---

entrance of the Parliament of India and many Veda Mantra-s quoted by constitutional authorities on various occasions are understood only on study of the Vedas and true inspiration can be drawn only by pondering over them. The inherent equality of all beings as embodiment of “sat, chit, ananda” has been emphasized in the Vedas and throughout the Vedic literature.

Many scholars have emphasized that Veda-s are also a source of scientific knowledge and we have to look into Vedas and other scriptural sources of India for the solution of modern problems, which the whole world is facing now. Unless students are taught the recitation of Vedas, knowledge content of Vedas and Vedic philosophy as an embodiment of spiritual and scientific knowledge, it is not possible to spread the message of Vedas to fulfill the aspiration of modern India.

The teaching of Veda (Vedic oral tradition/ Veda recitation/ Veda knowledge Tradition) is neither only religious education nor only religious instruction. It will be unreasonable to say that Vedic study is only a religious instruction. Veda-s are not religious texts only and they do not contain only religious tenets; they are the corpus of pure knowledge which are most useful to humanity as whole. Hence, instruction or education in Veda-s cannot be construed as only “religious education/religious instruction.”

Terming “teaching of Veda as a religious education” is not in consonance with the judgment of the Hon’ble Supreme Court (AIR 2013: 15 SCC 677), in Civil Appeal no. 6736 of 2004 (Date of judgment-3rd July 2013). The Vedas are not only religious texts, but they also contain the knowledge in the disciplines of mathematics, astronomy, meteorology, chemistry, hydraulics, physics, science and technology, agriculture, philosophy, yoga, education, poetics, grammar, linguistics etc. which has been brought out in the judgment by the Hon’ble Supreme Court of India.

### **Vedic education through establishment of Board in compliance with NEP-2020**

The National Education Policy-2020 firmly recognizes the Indian Knowledge Systems (also known as 'Sanskrit Knowledge Systems'), their

---

importance and their inclusion in the curriculum, and the flexible approach in combining various subjects. Arts' and Humanities' students will also learn science; try to acquire vocational subjects and soft skills. India's special heritage in the arts, sciences and other fields will be helpful in moving towards multi-disciplinary education. The policy has been formulated to combine and draw inspiration from India's rich, ancient and modern culture and knowledge systems and traditions. The importance, relevance and beauty of India's classical languages and literature is also very important for a meaningful understanding the national aspiration. Sanskrit, being an important modern language mentioned in the Eighth Schedule of Indian Constitution, its classical literature that is greater in volume than that of Latin and Greek put together, contains vast treasures of mathematics, philosophy, grammar, music, politics, medicine, architecture, metallurgy, drama, poetry, storytelling, and more (known as 'Sanskrit Knowledge Systems'). These rich Sanskrit Knowledge System legacies for world heritage should not only be nurtured and preserved for posterity but also enhanced through research and put in to use in our education system, curriculum and put to new uses. All of these literatures have been composed over thousands of years by people from all walks of life, with a wide range of socio-economic background and vibrant philosophy. Sanskrit will be taught in engaging and experiential as well as contemporary relevant methods. The use of Sanskrit knowledge system is exclusively through listening to sound and pronunciation. Sanskrit textbooks at the Foundation and Middle School level will be available in Simple Standard Sanskrit (SSS) to teach Sanskrit through Sanskrit (STS) and make its study enjoyable. Phonetics and pronunciation prescriptions in NEP 2020 apply to the Vedas, the oral tradition of the Vedas and Vedic education, as they are founded upon phonetics and pronunciation.

There is no clear distinction made between arts and science, between curricular and extra-curricular activities, between vocational and academic streams, etc. The emphasis in NEP 2020 is on the development of a multi-disciplinary and holistic education among the sciences, social sciences, arts, humanities and sports for a multi-disciplinary world to

---

ensure the unity and integrity of all knowledge. Moral, human and constitutional values like empathy, respect for others, cleanliness, courtesy, democratic spirit, spirit of service, respect for public property, scientific temper, freedom, responsibility, pluralism, equality and justice are emphasized.

The NEP-2020 at point no. 4.23 contains instructions on the pedagogic integration of essential subjects, skills and abilities. Students will be given a large amount of flexible options in choosing their individual curriculum; but in today's fast-changing world, all students must learn certain fundamental core subjects, skills and abilities to be a well-grounded, successful, innovative, adaptable and productive individual in modern society. Students must develop scientific temper and evidence based thinking, creativity and innovation, aesthetics and sense of art, oral and written expression and communication, health and nutrition, physical education, fitness, health and sport, collaboration and teamwork, problem solving and logical thinking, vocational exposure and skills, digital literacy, coding and computational thinking, ethics and moral reasoning, knowledge and practice of human and constitutional values, gender sensitivity, fundamental duties, citizenship skills and values, knowledge of India, environmental awareness etc. Knowledge of these skills include conservation, sanitation and hygiene, current affairs and important issues facing local communities, the states, the country and the world, as well as proficiency in multiple languages. In order to enhance the linguistic skills of children and to preserve these rich languages and their artistic treasures, all students in all schools, public or private, shall have the option of learning at least two years in one classical language of India and its related literature.

The NEP-2020 at point no. 4.27 states that -“Knowledge of India” includes knowledge from ancient India and its contributions to modern India and its successes and challenges, and a clear sense of India’s future aspirations with regard to education, health, environment, etc. These elements will be incorporated in an accurate and scientific manner throughout the school curriculum wherever relevant; in particular, Indian Knowledge Systems, including tribal knowledge and indigenous and

---

---

traditional ways of learning, will be covered and included in mathematics, astronomy, philosophy, yoga, architecture, medicine, agriculture, engineering, linguistics, literature, sports, games, as well as in governance, polity, conservation. It will have informative topics on inspirational personalities of ancient and modern India in the fields of medicinal practices, forest management, traditional (organic) crop cultivation, natural farming, indigenous sports, science and other fields.

The NEP-2020 at point no. 11.1 gives directions to move towards holistic and multidisciplinary education. India emphasizes an ancient tradition of learning in a holistic and multidisciplinary manner, including the knowledge of 64 arts such as singing and painting, scientific fields such as chemistry and mathematics, vocational fields such as carpentry, tailoring; professional work such as medicine and engineering, as well as the soft skills of communication, discussion and negotiation etc. which were also taught at ancient universities such as Takshashila and Nalanda. The idea that all branches of creative human endeavour, including mathematics, science, vocational subjects and soft skills, should be considered 'arts', has a predominantly Indian origin. This concept of 'knowledge of the many arts' or what is often called 'liberal arts' in modern times (i.e., a liberal conception of the arts) will be our part of education system.

At point No. 11.3 the NEP-2020 further reiterates that such an education system “would aim to develop all capacities of human beings - intellectual, aesthetic, social, physical, emotional, and moral in an integrated manner. Such an education will help develop well-rounded individuals that possess critical 21st century capacities in fields across the arts, humanities, languages, sciences, social sciences, and professional, technical, and vocational fields; an ethic of social engagement; soft skills, such as communication, discussion and debate; and rigorous specialization in a chosen field or fields. Such a holistic education shall be, in the long term, the approach of all undergraduate programmes, including those in professional, technical, and vocational disciplines.”

---

The NEP-2020 at point no. 22.1 contains instructions for the promotion of Indian languages, art and culture. India is a rich storehouse of culture – which has evolved over thousands of years, and is reflected in its art, literary works, customs, traditions, linguistic expressions, artifacts, historical and cultural heritage sites, etc. Traveling in India, experiencing Indian hospitality, buying beautiful handicrafts and handmade clothes of India, reading ancient literature of India, practicing yoga and meditation, getting inspired by Indian philosophy, participating in festivals, appreciating India's diverse music and art and watching Indian films are some of the ways through which millions of people around the world participate in, enjoy and benefit from this cultural heritage of India every day.

In NEP-2020 at point no. 22.2 there are instructions about Indian arts. Promotion of Indian art and culture is important for India and to all of us. To inculcate in children a sense of our own identity, belonging and an appreciation of other culture and identity, it is necessary to develop in children key abilities such as cultural awareness and expression. Unity, positive cultural identity and self-esteem can be built in children only by developing a sense and knowledge of their cultural history, art, language and tradition. Therefore, the contribution of cultural awareness and expression is important for personal and social well-being.

The core Vedic Education (Vedic Oral Tradition / Veda Path / Veda Knowledge Tradition) of Pratishthan along with other essential modern subjects- Sanskrit, English, Mother tongue, Mathematics, Social Science, Science, Computer Science, Philosophy, Yoga, Vedic Agriculture, Indian Art, Socially useful productive work etc., based on the IKS inputs are the foundations/sources of texts books of Pratishthan and Maharshi Sandipani Rashtriya Veda Sanskrit Shiksha Board. These inputs are in tune with the NEP 2020. The draft books are made available in pdf form keeping in view the NEP 2020 stipulations, requirements of MSRVP students and the advice of educational thinkers, authorities and policy of Maharshi Sandipani Rashtriya Veda Vidya Pratishthan, Ujjain. These books will be updated in line with NCFSE in future and finally will be made available in print form.

The Teachers of Veda, Sanskrit and Modern subjects in Rashtriya Adarsh Veda Vidyalaya, Ujjain and many teachers of Sanskrit and modern subjects in aided Veda Pathshalas of Pratishthan have worked for last two years tirelessly to prepare and present Sanskrit and modern subject text books in this form. I thank all of them from the bottom of my heart. Many eminent experts of the national level Institutes have helped in bringing quality in the textbooks by going through the texts from time to time. I thank all those experts and teachers of the schools. I extend my heartfelt gratitude to all my co-workers who have worked for DTP, drawing the sketches, art work and page setting.

All suggestions including constructive criticism are welcome for the improvement of the quality of the text books.

आपरितोषाद् विदुषां न साधु मन्ये प्रयोगविज्ञानम्।  
बलवदपि शिक्षितानाम् आत्मन्यप्रत्ययं चेतः ॥

(Abhijnanashakuntalam 1.02)

*Until the scholars are fully satisfied about the content, presentation, attainment of objective, I do not consider this effort to be successful, because even the scholars are not fully confident in the presentation without feedback from the stakeholders.*

**Prof. ViroopakshaV Jaddipal**  
**Secretary**

Maharshi Sandipani Rashtriya Veda Vidya Pratishthan, Ujjain  
Maharshi Sandipani Rashtriya Veda Sanskrit Shiksha Board, Ujjain

## FOREWORD

The presented textbook of Science for Class 10th in Class Vedbhushan V/Purvmadhyama-II/School Education has been published in compliance with the guidelines of the National Education Policy 2020. This course includes knowledge of Vedic Vangmay and ancient India and its contribution towards modern India and its successes and challenges and a clear sense of India's future aspirations in relation to education, health, environment etc. In particular, indigenous methods of learning based on Indian knowledge system and specific curriculum on forest management, traditional (organic) crop cultivation, natural farming etc. have been included. While developing the curriculum, care has been taken to ensure that various points and subjects can be easily understood through games. Video documentaries on inspirational personalities of ancient and modern India in science and other fields will be shown throughout the school curriculum. Students will be encouraged to visit different states as participants in cultural exchange programs.

To check the students' understanding of the subject, practice questions have been included at the end of each lesson, which include multiple choice questions and descriptive questions. Model question papers have been included at the end of the book so that students can self-evaluate themselves.



## CONTENTS

S.No.	Chapter Name	Page Number
1.	Chemical Reactions and Equations	1 – 6
2	Carbon and Its Compounds	7 – 14
3	Periodic Classification of Elements	15 – 23
4	Biological Process	24 – 29
5	Control and Coordination	30 – 37
6	Various Phenomena of Light	38 – 46
7	Human Eye and Colorful World	47 – 53
8	Electric Current	54 – 62
9	Magnetic Effects of Electric Current	63 – 70
10	Sources of Energy	71 – 83
11	Our Environment	83 – 95
	Model Question Paper	96 - 112

## Chapter - 1

### Chemical reactions and equations

Many chemical reactions take place every day in our daily life. In which substances change from one form to another. For example - burning of paper, warming of milk, rusting of iron etc.

#### Chemical equation -

Carbon dioxide gas is formed when carbon is heated in the presence of oxygen.

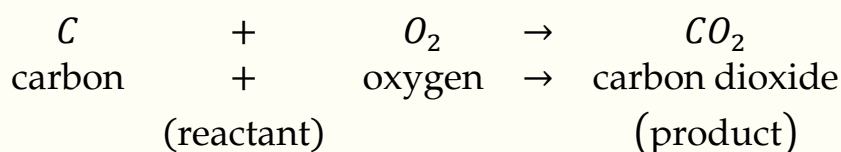

The substances participating in the chemical reaction are written on the left side before the arrow mark, they are called reactants or reactants and the product is formed on the right side of the arrow target.

Magnesium oxide is formed when magnesium is burnt in the presence of air.

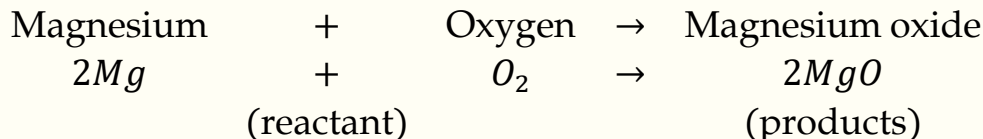

#### Balanced chemical equation

Equations in which the number of atoms in both the reactants and products are the same. is called a balanced chemical equation.

#### Balancing Chemical Equations -

**Step 1** First draw a box around the formula. We don't have to make changes inside the box.

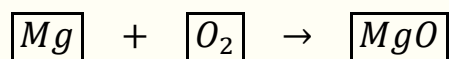

**Step 2** List the atoms present in the unbalanced equation.

Elements	Number of atoms in reactants	Number of atoms in products
Mg	1	1
O	2	1

**Step 3** Now choose the one with the largest number of atoms in the equation. On this basis we choose oxygen. There are 2 atoms of oxygen on the right side of the equation while there is only 1 atom on the left side.

Atoms of oxygen	Number of atoms in reactants	Number of atoms in products
(a) Initially	2( $O_2$ )	1( $MgO$ )
(b) to balance	2	1 × 2

**Step 4** Now let's balance the atoms.

Atoms of magnesium	Number of atoms in reactants	Number of atoms in products
(a) Initially	1( $Mg$ )	2( $MgO$ )
(b) to balance	1 × 2	2

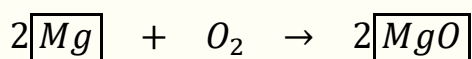

In the above equation, the number of atoms of the elements on both the sides is equal. Hence it is a balanced equation.

**Chemical reaction :-**

A chemical change in a substance is called a chemical reaction. That is, after the reaction, a new substance is formed.

**Types of chemical reaction -**

(a) **Conjugation reaction** - A chemical reaction in which two or more reactants combine to form a single product.

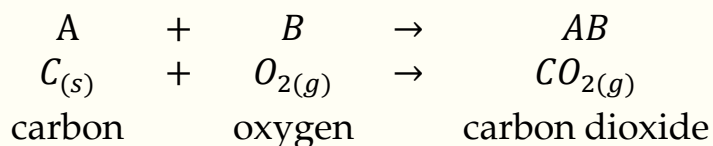

(b) **Decomposition reaction** : - In this reaction a single reactant breaks down to give smaller products.

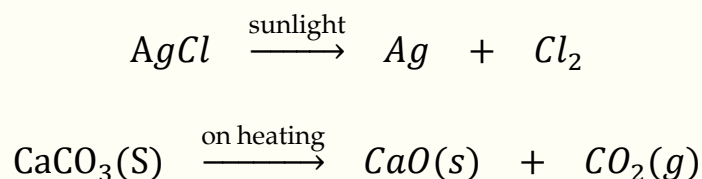

Conversion of silver chloride into silver and chlorine in the presence of sunlight

(c) **Displacement Reactions** - Such chemical reactions in which an atom or group of atoms in one reactant is replaced by an atom or group of atoms in another reactant. As a result of displacement reaction, the color of iron nail changes when it is put in copper sulphate solution.

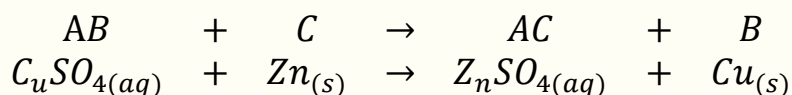

(d) **Double displacement reaction** - In this reaction, there is exchange of ions between two different atoms or group of atoms, it is called double displacement reaction.

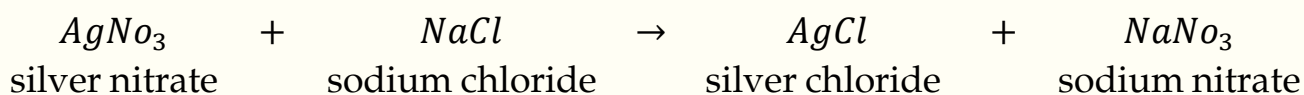

(e) **Redox reaction** - In this reaction, one reactant is oxidised and the other reactant is reduced.



Oxidation - Addition of oxygen in a chemical reaction is called oxidation.

Reduction - The release of oxygen in a chemical reaction is called reduction.

**Effect of oxidation reactions in our daily life**

(a) **Due to corrosion** - oxidation reaction, iron gets covered with a brown layer. Which is called rusting. Metal gets corroded by coming in contact with water vapour, acid iron. This process is called corrosion.

सुवर्णं रजतं ताम्रं तीक्ष्णं वङ्गभुजङ्गमाः ।  
लोहकं षड्विधं तच्च यथापूर्वं तदक्षयम् ॥

(रसार्णव 7.89.90 वै. वि. पृष्ठ 170)

This is the sequence of metals in terms of stability – gold, silver, copper, iron, tin and lead, among which gold metal does not rust Iron, tin and lead rust quickly.



2. As a result of the oxidation reaction, a brown layer is formed on the iron.
3. In a chemical reaction, the substances written on the left side before the arrow mark are called reactants.

Q. 4. Match the correct pair.

Column 'A'	Column 'B'
1. By combining the reactants in making a single product	a) Decomposition reaction
2. Breakdown of a single reactant into smaller products	b) Conjugation reaction
3. Addition of oxygen in a chemical reaction	c) Reduction
4. Release of oxygen in chemical reaction	d) Oxidation

Q. 5. Very short answer type questions

1. A reaction in which a substance breaks down into two smaller simpler molecules. What is the reaction called ?

Q. 6. Short Answer Type Questions

1. Balance the following chemical equation –

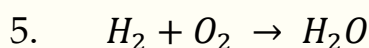
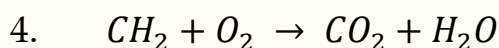
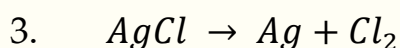
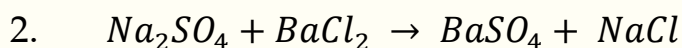
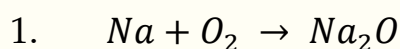

2. What is a conjugation reaction ? Explain with examples.
3. What is a decomposition reaction ?
4. What is a chemical reaction ?



## Q. 7. Long Answer Type Questions

1. What is displacement reaction ? Explain with examples.
2. Define reduction and oxidation.
3. Why does the color of the solution change when an iron nail is dipped in a solution of  $CuSO_4$ ?

### Project work -

1. To study the chemical reaction of iron nail with aqueous copper sulphate solution and to study the combustion of magnesium ribbon in air.
2. To observe the reaction of metals with dilute acids.

## Chapter - 2

### Carbon and its Compounds

In this chapter, we will study about the properties of carbon and its compounds.

#### 2.1 Characteristics of carbon atom -

1. The atomic number of carbon is 6. Its chemical symbol is C.
2. The electronic configuration of the carbon atom is 2, 4. K = 2, L = 4
3. The valency of carbon atom is 4. The valency of carbon is satisfied in the following way.

#### A) Formation of methane (CH<sub>4</sub>) and carbon tetra chloride (CCl<sub>4</sub>) -

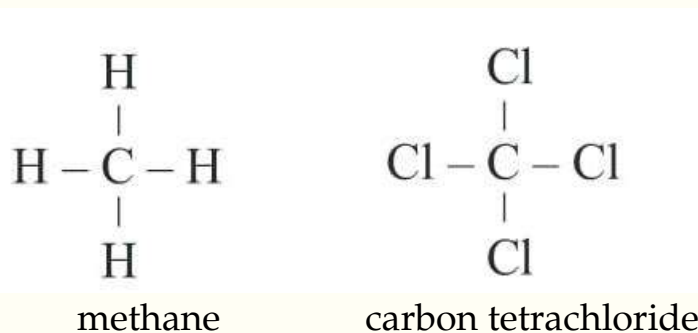

#### b) formation of formaldehyde

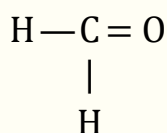

#### c) Formation of cyanide and carbon dioxide



4. The geometry of the carbon atom is tetrahedral and the bond angle is 109°28'.

#### 2.2 Universal nature of carbon -

- a) Carbon atoms form chains by forming single, double or triple bonds with other carbon atoms. Compounds of carbon linked with a single bond are called saturated compounds and compounds of carbon with double or triple bonds are called unsaturated compounds.



- b) The carbon atom has the ability to form compounds by forming bonds with other carbon atoms and with other combining elements like chlorine, fluorine, oxygen, hydrogen, nitrogen, sulphur, etc.

### 2.3 IUPAC method –

It is the international system of naming organic compounds. According to this method, the naming of alkane, alkyne, alkyne (hydrocarbon) can be done in the following way.

1. In the nomenclature of hydrocarbons, its prefix is written on the basis of the number of carbon atoms present in the molecule of the organic compound.
2. On the basis of the bond present in the molecule of an organic compound, its annexure is written.
3. The name of hydrocarbon is written by combining prefix and suffix.

Table 2.1 Determination of Attachment in Hydrocarbons

Type of bond between carbon and carbon in the molecule		Suffix
(i)	Alkene series (single bond) $\begin{array}{c}   \quad   \\ - C - C - \\   \quad   \end{array}$	-ane (-ane)
(ii)	Alkyne series (double bond) $> C = C <$	-ene (-ene)
(iii)	Alkyne series (Tribond) $- C \equiv C -$	-yne

Table 2.2 Determination of Attachment in Hydrocarbons

The number of carbon atoms in the molecule	prefix
$C_1$	Meth
$C_2$	Eth
$C_3$	Prop
$C_4$	Butt
$C_5$	Pent
$C_6$	Hex

$C_7$	Hept
$C_8$	Oct
$C_9$	Non
$C_{10}$	Deck

## 2.4 Saturated and Unsaturated Carbon Compounds -

### Saturated hydrocarbons

The organic compounds formed by the formation of single covalent bonds between carbon atoms and hydrogen atoms are called saturated hydrocarbons. E.g. Methane, Ethane, Propane etc.

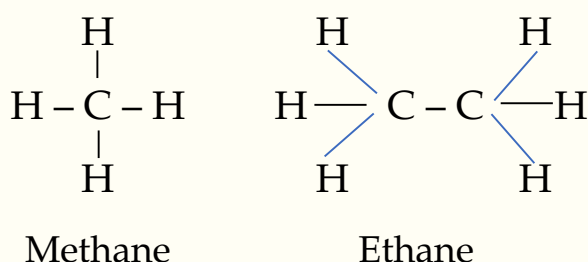

### Unsaturated hydrocarbons

Organic compounds formed by double or triple covalent bonds between carbon atoms and hydrogen atoms are called unsaturated hydrogen. Eg – ethene, propene, ethyne etc.

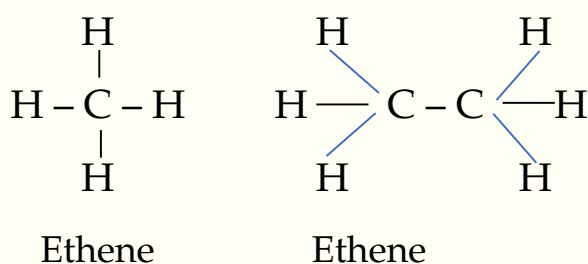

## 2.5 Chains, Branches and Rings –

Table 2.3

Hydrocarbon Name	Molecular	Structural Formula
Methane	$\text{CH}_4$	$\begin{array}{c} \text{H} \\   \\ \text{H} - \text{C} - \text{H} \\   \\ \text{H} \end{array}$

Ethane	$C_2H_6$	$  \begin{array}{c}  H & & H \\  & \diagdown & / \\  H - & C - C & - H \\  & / & \diagdown \\  H & & H  \end{array}  $
Propane	$C_3H_8$	$  \begin{array}{cccc}  & H & H & H \\  &   &   &   \\  H - & C - C - C - H \\  &   &   &   \\  & H & H & H  \end{array}  $
Butane	$C_4H_{10}$	$  \begin{array}{cccc}  & H & H & H & H \\  &   &   &   &   \\  H - & C - C - C - C - H \\  &   &   &   &   \\  & H & H & H & H  \end{array}  $

Formulas and structures of saturated compounds of carbon and hydrogen.

## 2.6 Allotropes of Carbon

Two or more forms of an element which differ from each other in physical properties are called allotropes. This quality is called allotropes.

We can classify the allotropes of carbon as follows –

Carbon	
Crystalline allotrope	Amorphous allotrope
Diamond	Coal
Graphite	Coke
Fullerene	Wood charcoal
	Animal charcoal
	Soot
	Gas carbon

### 1. Crystalline form -

Those allotropes of carbon in which fixed geometry and fixed bond angles are found. are called crystalline allotropes. As -

## A) **Diamond -**

- 1) Diamond is a bad conductor of electricity and heat.
- 2) Pure diamond is colourless, transparent and extremely hard.
- 3) Diamond forms a three dimensional tetrahedral structure.

### **Use of diamond**

- 1) In the machine for cutting rocks and marble and glass.
- 2) In the manufacture of gems and jewellery.

## b) **graphite -**

- 1) Graphite is a good conductor of electricity and heat.
- 2) Graphite is a soft and smooth substance of black colour.
- 3) Graphite forms hexagonal ring structure.

### **Uses of Graphite**

- 1) Graphite is used in pencils.
- 2) Graphite is used as a moderator to slow down the nuclear reactions in nuclear reactors.
- 3) Graphite powder is used as a lubricant in heavy machines.
- 4) In making electrodes.

## c) **fullerene**

60, 70 or even more carbon atoms of carbon . Of these, C-60 is the most stable. Fullerenes are used in the purification of natural gas.

Important organic compounds useful in daily life –

a) **Freon or chloro** – fluoro carbon – forms compounds by joining chlorine and fluorine to the carbon atom. These are called freon or chloro-fluoro carbon ( CFC) .

### **Uses of Freon**

As refrigerant in air conditioners, refrigerators, perfumes.

b) **CNG ( CNG)** - Its full name is Compressed Natural Gas. It is a mixture of methane and other hydrocarbons. Due to the low percentage

of carbon in it, smoke does not come out on burning and it causes less pollution. Natural gas can be obtained by mining the earth in the earth's crust. It is found underground in the form of a layer above petroleum. CNG is obtained by compressing natural gas at high temperature .

**CNG -**

CNG is used as a fuel in light vehicles.

**c) LPG**

LPG is Liquefied Petroleum Gas. It is a mixture of butane, propane and other hydrocarbon gases. On fractional distillation of petroleum, along with the constituents of petroleum, petroleum gas is obtained. Petroleum gas is converted into a liquid by compressing it under high pressure. It is a highly inflammable gas.

**LPG -**

LPG is used as a fuel for cooking in homes.

पृथिव्याः सधस्थार्ग्निं पुरीष्यमङ्गिरस्वत्वनामि ।  
ज्योतिष्मन्तं त्वाग्ने सुप्रतीकमजस्रेण भानुना दीद्यतम् ॥

(यजु. 11.28)

Natural gas is mentioned in Yajurveda, the word Purishya Agni has been used for underground gas.

**Soaps and Detergents -**

Soap molecules are sodium and potassium salts of long chain carboxylic acids. The ionic part of the soap dissolves in water, while the carbon chain dissolves in oil.

## Practice Work

### Q. 1. Multiple Choice Questions -

- (1)  $\text{CH}_4$  is a hydrocarbon -
  - a) Propane
  - b) Butane
  - c) Methane
  - d) Propene
- (2) If the number of carbon atoms present in the molecule of an organic compound is 2, then the prefix will be -
  - a) Prop
  - b) Eth
  - e) But
  - d) Pant
- (3) Used as a cutter to cut glass -
  - a) Graphite
  - b) Diamond
  - c) Fullerene
  - d) Freon

### Q. 2. Fill in the blanks -

- (1) Graphite is a ..... of heat and electricity.
- (2) The geometry of carbon atom is .....
- (3) ..... is used in the purification of natural gas.

### Q. 3. Mark True (✓) or False (✗) against the following statements.

- (1) Soap molecules are sodium and potassium salts of long chain carboxylic acids.
- (2) LPG is used as a fuel for cooking in homes.
- (3) Graphite is used in making pencils.

### Q. 4. Match the correct pair.

- | Column 'A'                  | Column 'B'                       |
|-----------------------------|----------------------------------|
| (1) Diamond                 | a) Good conductor of electricity |
| (2) Graphite                | b) Poor conductor of electricity |
| (3) Saturated hydrocarbon   | c) Ethene                        |
| (4) Unsaturated hydrocarbon | d) Ethane                        |



Q. 5. Very short answer type questions -

- (1) What is the full form of LPG?
- (2) What is the use of Freon?
- (3) Write the names of the crystalline allotropes of carbon.

Q. 6. Short Answer Type Questions -

- (1) What is CNG? Write the uses of CNG .
- (2) What are saturated hydrocarbons?
- (3) Write the uses of LPG.

Q. 7. Long answer type questions -

- (1) Write the characteristics of carbon atom.

## Chapter - 3

### Periodic Classification of Elements

Dear students ! In the previous class, we studied the substances around us in the form of elements, mixtures and compounds and understood the physical and chemical properties of elements, mixtures and compounds. In this chapter, we will study the elements by classifying them on the basis of their properties.

**3.1 Need for classification** - It is extremely difficult to study the physical and chemical properties of different elements and the properties of the compounds formed from the elements separately. To study the elements easily, scientists have classified them on the basis of their properties, so that the elements can be studied easily.

#### 3.2 Classification - Elementary Classification of Elements

a) Dobereiner's triad - Element atomic mass

Element	Atomic Mass	Element	Atomic Mass	Element	Atomic Mass
Li	7	Ca	40	Cl	35
Na	23	Sr	88	Br	80
K	39	Ba	137	I	127

Table 3.1 Dobereiner's Triad

Dobereiner made groups of three elements with similar properties. The elements in these groups were arranged in order of increasing atomic mass. The atomic weight of the middle element in this group was approximately equal to the average of the atomic weights of the remaining two elements. Since only three triples were known, this rule became inapplicable.

b) Newland's octets -

Element	Li	Be	B	C	N	O	F
Atomic mass	7	9	11	12	14	16	19
Element	Na	Mg	Al	Si	P	S	Cl
Atomic mass	23	24	27	28	31	32	35.5



<b>Element</b>	K	Ca					
<b>Atomic mass</b>	39	40					

Table - 3.2 Newland's Octaves

1866, Newland arranged the elements known up to that time in the increasing order of their atomic mass (ascending order). He found that the properties of each eighth element are similar to the properties of the first element. Example - Sodium (Na) is in eighth place after lithium and the properties of both were almost similar. Similarly, the properties of beryllium (Be) and magnesium (Mg) are similar.

Is similar to the seven notes (sa, re, ga, ma, p, dha, ni, sa) of Indian music. Because after seven vowels only the eighth vowel comes. This rule did not prove useful for elements beyond calcium (Ca).

### 3.3 Periodic Table of Mendeleev –

Group	I		II		III		IV		V		VI		VII		VIII		
oxide	R <sub>2</sub> O		RO		R <sub>2</sub> O <sub>3</sub>		RO <sub>2</sub>		R <sub>2</sub> O <sub>5</sub>		RO <sub>3</sub>		R <sub>2</sub> O <sub>7</sub>		RO <sub>4</sub>		
hydride	RH		RH <sub>2</sub>		RH <sub>3</sub>		RH <sub>4</sub>		RH <sub>3</sub>		RH <sub>2</sub>		RH				
Period	A	B	A	B	A	B	A	B	A	B	A	B	A	B	Transition series		
1	H 1.008																
2	Li 6.939		Be 9.012		B 10.81		C 12.011		N 14.007		O 15.999		F 18.998				
3	Na 22.99		Mg 24.31		Al 29.98		Si 28.09		P 30.974		S 32.06		Cl 35.453				
4 first	K		Ca		Sc		Ti		V		Cr		Mn	Fe	Co	Ni	
Category	39.102		40.08		44.96		47.90		50.94		50.20		54.94	55.85	58.93	58.71	
Second	Cu		Zn		Ga		Ge		As		Se		Br				
Category	63.54		65.37		69.72		69.72		74.92		78.96		79.909				
5 first	Rb		Sr		Y		Zr		Nb		Mo		Tc	Ru	Rh	Pd	
Category	85.47		87.62		88.91		91.22		92.91		95.94		99	101.07	102.91	106.4	
Second	Ag		Cd		In		Sn		Sb		Te		I				
Category	107.87		112.40		114.82		118.69		121.75		127.60		12.90				

<b>6 first</b>	Cs	Ba	La	Hf	Ta	W		Os	Ir	Pt
<b>Category</b>	132.90	137.34	138.91	178.49	180.95	183.85		190.2	192.2	195.09
<b>Second</b>	Au	Hg	Tl	Pb	Bi					
<b>Category</b>	196.97	200.59	204.37	207.19	208.98					

Table 3.3 Mendeleev's Periodic Table

Mendeleev found in his studies that the physical and chemical properties of elements are periodic functions of their atomic weights. That is, if the elements are placed in the increasing order of their atomic weights, then after a certain interval, the sequence of elements with properties similar to the same element comes. Mendeleev prepared the periodic table of elements on this basis. Elements were placed in 6 periods (horizontal rows) and 8 groups (vertical columns) in the table. Mendeleev placed elements of the same type of properties in the same class. Spaces were left in the periodic table for elements to be discovered in the future.

#### Some shortcomings of Mendeleev's periodic table –

- 1) Different isotopes of the same element having different atomic masses are not given a place in the table.
- 2) Elements with lower atomic mass were placed before the elements with higher atomic mass.
- 3) Elements with some similar properties were placed in different groups and elements with dissimilar properties were placed in the same group.

#### 3.4 Modern Periodic Table –

Henry Moseley found in his studies in 1913 that the physical and chemical properties of elements are periodic functions of their atomic numbers. In the modern periodic table, elements were placed on the basis of increasing atomic numbers. There are 18 vertical columns in this periodic table. Each column is called a group. Elements of a group have similar physical and chemical properties because the elements have the same number of electrons in their outer shell. There are 7 periods in this periodic table. Elements of a period have the same number of electron orbits.

Group→	1	2	3	4	5	6	7	8	9	10	11	12	13	14	15	16	17	18
↓ Period																		
1	1 H																	2 He
2	3 Li	4 Be											5 B	6 C	7 N	8 O	9 F	10 Ne
3	11 Na	12 Mg											13 Al	14 Si	15 P	16 S	17 Cl	18 Ar
4	19 K	20 Ca	21 Sc	22 Ti	23 V	24 Cr	25 Mn	26 Fe	27 Co	28 Ni	29 Cu	30 Zn	31 Ga	32 Ge	33 As	34 Se	35 Br	36 Kr
5	37 Rb	38 Sr	39 Y	40 Zr	41 Nb	42 Mo	43 Tc	44 Ru	45 Rh	46 Pd	47 Ag	48 Cd	49 In	50 Sn	51 Sb	52 Te	53 I	54 Xe
6	55 Cs	56 Ba		72 Hf	73 Ta	74 W	75 Re	76 Os	77 Ir	78 Pt	79 Au	80 Hg	81 Tl	82 Pb	83 Bi	84 Po	85 At	86 Rn
7	87 Fr	88 Ra		104 Rf	105 Db	106 Sg	107 Bh	108 Hs	109 Mt	110 Ds	111 Rg	112 Cn	113 Nh	114 Fl	115 Mc	116 Lv	117 Ts	118 Og

Lanthanide	57 La	58 Ce	59 Pr	60 Nd	61 Pm	62 Sm	63 Eu	64 Gd	65 Tb	66 Dy	67 Ho	68 Er	69 Tm	70 Yb	71 Lu
Actinide	89 Ac	90 Th	91 Pa	92 U	93 Np	94 Pu	95 Am	96 Cm	97 Bk	98 Cf	99 Es	100 Fm	101 Md	102 No	103 Lr

Categories of Elements in the Periodic Table														
Metal										Non-metal				
Alkali Metal	Alkaline Earth Metal	Transition Elements		Transition Metal		Other Metal	Metalloid	Other Non-metal	Halogen	Inert Gas				
		Lanthanide	Actinide											

Table 3.4 - Modern Periodic Table

### Classification of elements -

- Group 1 and group 2 elements are called S block elements. They are located on the left side of the periodic table. Group 1 elements are called alkali metals and group 2 elements are called alkaline earth metals.
- The elements of group 3 to 12 are called D block elements. It is located in the middle of the periodic table. These are called transition elements. In these elements, the valence electrons are present in more than one shell.
- The elements of group 13 to 18 are called P block elements. They are located in the right part of the periodic table. Group 18 elements are called ideal gases. It is also called zero group because the number of electrons in its outermost shell is zero in other elements except helium element, these are inert gases.
- In the horizontal rows, the elements of the first row (4f series) lanthanides and the elements of the second row (5f series) actinides series are called F block elements, these are inner transition elements.

## Trend of modern periodic table -

### Connectivity

The number of electrons present in the outermost shell of an atom of an element is called the valency of the element.

### Atomic size

The distance of the outermost shell from the center of the atom called the size of the atom. On moving from left to right in the periodic table, the size of an atom decreases because the increase in charge on the nucleus pulls the electrons towards the nucleus. The size of an atom increases from top to bottom in the periodic table. This happens because on coming down a new cell is added to it.

### Metallic and non-metallic properties -

Metallic character increases on moving from top to bottom in the periodic table and metallic character decreases on moving from left to right in the period.

Sl.No.	Element Name	Symbol	Sl.No.	Element Name	Symbol	Sl.No.	Element Name	Symbol
1	Hydrogen	H	37	Rubidium	Rb	73	Tantalum	Ta
2	Helium	He	38	Strontium	Sr	74	Tungsten	W
3	Lithium	Li	39	Yttrium	Y	75	Rhenium	Re
4	Beryllium	Be	40	Zirconium	Zr	76	Osmium	Os
5	Boron	B	41	Niobium	Nb	77	Iridium	Ir
6	Carbon	C	42	Molybdenum	Mo	78	Platinum	Pt
7	Nitrogen	N	43	Technetium	Tc	79	Gold	Au
8	Oxygen	O	44	Ruthenium	Ru	80	Mercury	Hg

9	Fluorine	F	45	Rhodium	Rh	81	Thallium	Tl
10	Neon	Ne	46	Palladium	Pd	82	Lead	Pb
11	Sodium	Na	47	Silver	Ag	83	Bismuth	Bi
12	Magnesium	Mg	48	Cadmium	Cd	84	Polonium	Po
13	Aluminum	Al	49	Indium	In	85	Astatine	At
14	Silicon	Si	50	Tin	Sn	86	Radon	Rn
15	Phosphorus	P	51	Antimony	Sb	87	Francium	Fr
16	Sulfur	S	52	Tellurium	Te	88	Radium	Ra
17	Chlorine	Cl	53	Iodine	I	89	Actinium	Ac
18	Argon	Ar	54	Xenon	Xe	90	Thorium	Th
19	Potassium	K	55	Cesium	Cs	91	Protactinium	Pa
20	Calcium	Ca	56	Barium	Ba	92	Uranium	U
21	Scandium	Sc	57	Lanthanum	La	93	Neptunium	Np
22	Titanium	Ti	58	Cerium	Ce	94	Plutonium	Pu
23	Vanadium	V	59	Praseodymium	Pr	95	Americium	Am
24	Chromium	Cr	60	Neodymium	Nd	96	Curium	Cm
25	Manganese	Mn	61	Promethium	Pm	97	Berkelium	Bk
26	Iron	Fe	62	Samarium	Sm	98	Californium	Cf
27	Cobalt	Co	63	Europium	Eu	99	Einsteinium	Es
28	Nickel	Ni	64	Gadolinium	Gd	100	Fermium	Fm



29	Copper	Cu	65	Terbium	Tb	101	Mendelevium	Md
30	Zinc	Zn	66	Dysprosium	Dy	102	Nobelium	No
31	Gallium	Ga	67	Holmium	Ho	103	Lawrencium	Lr
32	Germanium	Ge	68	Erbium	Er	104	Rutherfordium	Rf
33	Arsenic	As	69	Thulium	Tm	105	Dubnium	Db
34	Selenium	Se	70	Ytterbium	Yb	106	Seaborgium	Sg
35	Bromine	Br	71	Lutetium	Lu	107	Bohrium	Bh
36	Krypton	Kr	72	Hafnium	Hf	108	Hassium	Hs



## Practice Work

Q. 1. Select the correct option -

- (1) The atomic size in the periodic table from left to right -
  - a) Increases
  - b) Decreases
  - c) Remains constant
  - d) Remains irregular
- (2) Mendeleev's periodic table is based on which property of matter-
  - a) Atomic mass
  - b) Atomic number
  - c) Valency
  - d) Atomic structure
- (3) The number of groups in the modern periodic table is -
  - a) 7
  - b) 8
  - c) 20
  - d) 18

Q. 2. Fill in the blanks -

- (1) The first periodic classification of elements was given by .....
- (2) Inert gases are called the members of the ..... group.
- (3) The metallic properties of the periodic table from left to right are.....

Q. 3. Mark True (✓) or False (✗) against the following statements.

1. The number of electrons in the outermost shell of inert gases is zero.
2. On moving from top to bottom in the periodic table, the size of the atom increases.
3. Elements from group 13 to group 18 in the modern periodic table are called P block elements.

Q. 4. Match the correct pair.

- | Column 'A'    | Column 'B' |
|---------------|------------|
| (1) Halogen   | a) Na      |
| (2) Inert gas | b) C       |
| (3) Metal     | c) F       |
| (4) Nonmetal  | d) Ne      |



Q. 5. Very short answer type questions -

- (1) What is the other name of d block elements?
- (2) What are the horizontal rows in the periodic table called?
- (3) What is the number of electrons present in the outermost shell of an atom of an element called?

Q. 6. Short Answer Type Questions -

- (1) On what basis was the modern periodic table prepared by Henry Moseley?
- (2) What is Newland's rule of octaves?
- (3) What is the need to classify elements?

Q. 7. Long answer type questions -

- (1) How are the elements classified in the modern periodic table?



## Chapter - 4

### Lift Process

Many biological processes like nutrition, respiration, excretion etc. remain dynamic in living beings. Due to these processes, various components of the living organism keep breaking down, such components need to be repaired or replaced with new components. Hence all the processes which collectively perform maintenance work. are called biological processes. These processes are – nutrition, respiration, transport, excretion etc.

#### Nutrition -

All living organisms require energy for functioning and for maintenance processes. The living organism obtains this energy from the ingestion of food. Therefore, the process of taking food by living beings and obtaining energy by using it is called nutrition. The nutrition process can be divided into two parts.

a) Autotrophic Nutrition      b) Heterotrophic Nutrition

#### A) Autotrophic nutrition -

Green plants and some bacteria manufacture their own food. Such organisms are called autotrophic organisms. Autotrophic organisms obtain energy from food produced by themselves. Getting nutrition from the food produced by oneself is called autotrophic nutrition.

Autotrophic organisms prepare their food by the process of photosynthesis. Essential substances for photosynthesis – sunlight, carbon dioxide, gas, water and chlorophyll etc.

**Process of Photosynthesis** - Green plastids (chloroplast) are present in the leaves of plants, in which chlorophyll is present. The color of the leaves is green due to the presence of chlorophyll. This chlorophyll, present in the leaves, absorbs energy from sunlight and converts light energy into chemical energy by chemical changes. The roots of trees and plants take water from the ground and the microscopic holes present on the surface of the leaves are called stomata. It absorbs carbon dioxide gas from the atmosphere. In this way, plants prepare their own food (glucose) by the process of photosynthesis.



Chlorophyll

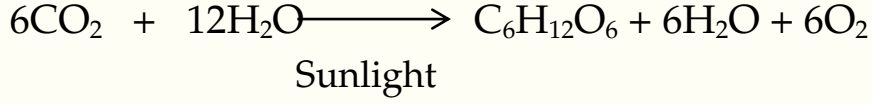

Carbon dioxide Water

Glucose

Oxygen

स्तोमेन हि दिवि देवासो अग्निमजीजनञ्छक्तिभी रोदसिप्राम्।  
तमू अकृण्वन् त्रेधा भुवे कं स ओषधीः पचति विश्वरूपाः ॥

(ऋग. 10.88.10)

It is due to solar energy all trees and plants prepare their food. All fruits and grains ripen with solar energy.

अग्नेयीरसि स्वावेश ऽ उन्नेतृणामेतस्य वित्तादधि त्वा स्थास्यति देवस्त्वा सविता  
मध्वानक्तु सुपिप्पलाभ्यस्त्वौषधीभ्यः।

(यजु. 6.2)

It is the sun that gives strength to all the medicines that bear fruit and produces sweetness in the fruits with its heat.

अधुक्षत् पिप्युषीमिषमूर्जं सप्तपन्दीमरिः। सूर्यस्य सप्त रश्मिभिः ॥

(ऋग. 8.72.16)

Trees receive powerful energy from the seven colored rays of the sun.

## B) Heterotrophic nutrition -

When an organism receives nutrition from the food made by other organisms, then this type of organism is called heterotrophic organism and this type of nutrition is called heterotrophic nutrition. The mode of nutrition varies depending on the nature and availability of food, as well as the type of nutrition received depends on the way the organism consumes food. Some creatures like - cow, man, horse, elephant, lion etc. By ingesting food, the energy generated by the digestion of food inside the body is used for maintenance and daily work. Whereas organisms like fungi, mushrooms, yeast etc. decompose the food outside the body and absorb it.

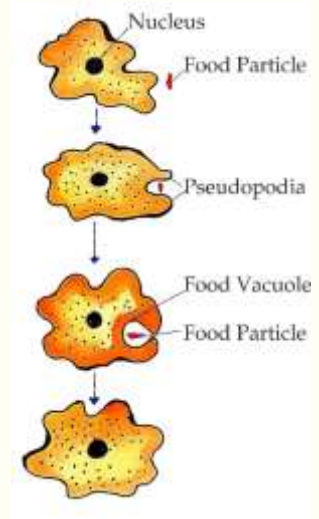

## Nutrition in Amoeba

Amoeba is a unicellular organism. Finger shaped temporary outgrowths are present on the surface of amoeba. The amoeba surrounds

the food with the help of these temporary outgrowths which coalesce to form food vacuoles. Within this food vacuole, complex substances are broken down into simple substances and the digested food is absorbed into the cytoplasm and the undigested food is thrown out of the body.

**Nutrition in Human** - Nutrition in human includes the requirement of nutrients, the method of ingestion (food intake) and the method of its utilization in the body.

Some constituents – such as carbohydrates – are complex substances these complex substances cannot be used directly in this form. So it is necessary to convert them into simpler substances.

The conversion or breaking down of complex foods into simple substances is called breakdown and this process is called digestion.

Digestion in humans - The whole process of digestion of food passes through five stages.

1. Ingestion
2. Digestion
3. Absorption
4. Assimilation
5. Excretion

**Ingestion** - Taking food in the mouth is called ingestion.

**Digestion** - Digestion of food in humans starts from the mouth. This continues till the small intestine. Food is chewed with the help of teeth located in the mouth, due to which the food is divided into small pieces. Saliva is secreted from the salivary glands located in the mouth, which convert starch (starch) into sugar (glucose) when mixed with food. The enzymes present in saliva destroy the harmful bacteria present in the food.



**Digestion in the stomach** - Food reaches the stomach through the esophagus. The stomach is a sac-like structure with thick walls. It is flat and U shaped. Food stays in the stomach for about four hours. Gastric juice (digestive juice) and hydrochloric acid emerge from the pyloric glands of the stomach.

Digestive juice (gastric juice) breaks down proteins into simpler substances and hydrochloric acid destroys bacteria present with food and makes food acidic, which helps the (digestive) juices to function.

**Digestion in the small intestine (Pchasya) :-** The small intestine is a highly coiled tube about 7.5 meters long. As soon as the food reaches the stomach, bile juice coming out of the liver is mixed in it. Bile juice is alkaline and it turns food from acidic to alkaline. Bile juice plays an important role in the digestion of fats. Liver is the largest gland of the body which is located in the upper part of the abdomen.

Here pancreatic juice comes from the pancreas and is mixed in the food. Pancreas is a large gland of light yellow color which is located just below the stomach. Pancreatic juice converts carbohydrates and proteins into simpler forms.

**Absorption in the small intestine –** The digested food is absorbed and moves into the blood vessels located in the wall of the small intestine. This process is called absorption.

**Assimilation :-** The transfer of absorbed substances to different parts of the body by the blood vessels. Where they are used to make complex substances. This process is called assimilation.

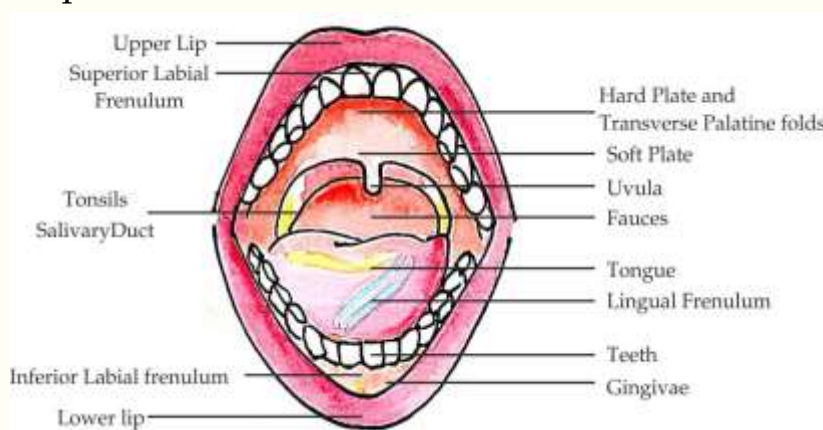

Fig. 4.3 – Mouth and oral cavity

**Digestion in the colon :-** The colon is wider and shorter than the small intestine. It is about 1.5 meters long. Its main function is to absorb water and some salts. The remaining undigested material goes into the rectum. And remains in the form of semi-solid feces. From time to time the faeces are expelled through the anus. This is called expulsion.

## Practice Work

### Q. 1. Multiple Choice Questions -

- (1) Which part of the alimentary canal receives bile juice from the liver?
  - a) Stomach
  - b) Small intestine
  - c) Large intestine
  - d) Esophagus
- (2) In which part of the alimentary canal the food is finally digested?
  - a) Stomach
  - b) Oral cavity
  - c) Large intestine
  - d) Small intestine
- (3) In what form is the internal (cellular) energy stored in autotrophs?
  - a) Glycogen
  - b) Protein
  - c) Starch
  - d) Fatty acid

### Q. 2. Fill in the blanks -

- (1) The whole process of digestion of food in humans passes through ..... stages.
- (2) ..... is present in the leaves of plants.
- (3) The conversion of complex food substances into simple substances is called .....

### Q. 3. Mark True (✓) or False (✗) against the following statements.

1. In heterotrophic nutrition, complex substances prepared by other organisms are ingested.
2. Photosynthesis takes place in the leaves of the plant.
3. The colon is wider and shorter than the small intestine.

### Q. 4. Match the correct pair.

- | Column 'A'                | Column 'B'    |
|---------------------------|---------------|
| (1) Autotrophic nutrition | a) Bile juice |

- (2) Heterotrophic nutrition
- (3) Stomach
- (4) Liver
- b) Hydrochloric acid
- c) Plants
- d) Deer

Q. 5. Very short answer type questions

- (1) Name the pigment present in the leaves of green plants which absorbs sunlight.

Q. 6. Short Answer Type Questions -

- (1) What is the difference between autotrophic nutrition and heterotrophic nutrition ?
- (2) From where does the plant get the raw material required for photosynthesis ?
- (3) What is the role of acid in our stomach ?
- (4) What is the function of digestive enzymes ?
- (5) How is the small intestine designed to absorb digested food ?

Q. 7. Long Answer Type Questions

- (1) How are carbohydrates, proteins and fats digested in humans ?

## Chapter - 5

### Control and Coordination

All living beings respond to changes in the environment. These changes happening in the environment according to which living beings respond are called stimuli . Like light, heat, cold, sound, fragrance, touch etc. live reacts accordingly. Plants and animals respond to stimuli in different ways.

#### Control and coordination in animals

Control and coordination in animals is done by two main systems-

(a) Nervous system

(b) Endocrine system

#### Nervous system

The system by which signals are transmitted from one part to other parts of the body of animals. It is called nervous system.

Control and coordination is provided by the nervous system and muscle tissue.

The nervous system is made up of an organized network of nerve cells or neurons, and it carries information from one part of the body to another through electrical impulses.

**Receptors** : Receptors are specialized ends of nerve cells that detect information from the environment. These receptors are located in our sense organs.

- (a) Ear : Hearing  
Body balance
- (b) Eye : Photoreceptor  
Look
- (c) Skin : Heat receptor  
Hot and cold  
Touch
- (d) Nose : Breather

- Smell detection
- (e) Tongue : Chemo sensory receptor
- Taste detection

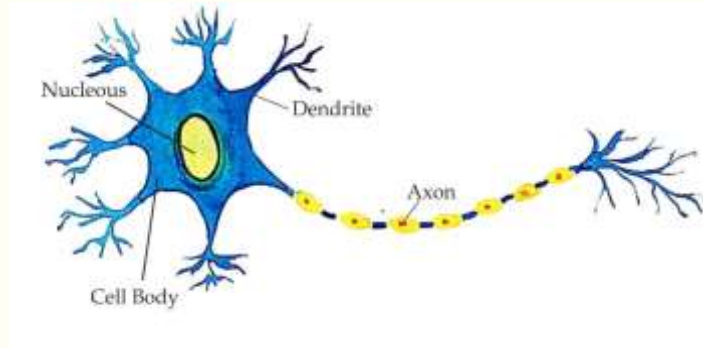

Figure 5.1

**Nerve Cell (Neuron):** It is the structural and functional unit of the nervous system.

**Parts of a nerve cell (neuron):**

- (a) **Spindles:** Thread-like structures projecting from the cell body, which receive information.
- (b) **Cell body:** The information received moves in the form of electrical impulses.
- (c) **Axon :** It transmits the electrical impulse of information from the cell body to the dendrite of another neuron.

**Synapse:** It is the space between the terminal end of the nerve and the dendrite of the next nerve cell. Here the electrical impulse is converted into a chemical signal so that it can be transmitted further.

**Reflex action:** A quick and sudden response to a stimulus is called a reflex action. Example: Withdrawal of the hand on touching a hot object.

**Reflex arc:** The path along which the electrical impulse travels during reflex action is called reflex arc .

excitation heat

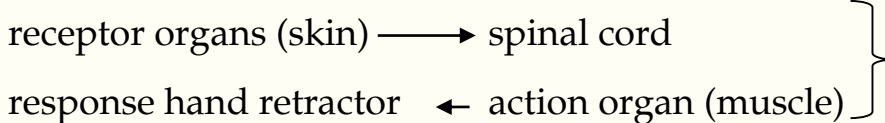



It is of three types:

- (i) **Voluntary:** Controlled by the forebrain. Example: speak, write
- (ii) **Involuntary:** Controlled by the mid and hindbrain. Example: breathing, heartbeat
- (iii) **Reflex action:** It is controlled by the spinal cord. Example: Withdrawal of the hand after touching a hot object.

**Need for reflex action:** In some situations like touching a hot object, pricking a sharp object, we have to act immediately otherwise our body may be harmed. Here the response originates from the spinal cord instead of the brain, which is quick.

Human Nervous System			
Central nervous system (CNC)		Peripheral nervous system (PNS)	
Brain	Spinal	Cranial nerves (originates from the brain)	Spinal nerves (originates from the spinal cord)

### Human brain

The brain is the center of coordination of all activities. It has three main parts.

- (a) Forebrain                      (b) Midbrain                      (c) Hindbrain

a) **Forebrain:** It is the most complex and specialized part of the brain. It is also called brain.

### Work :

- (i) The main thinking part of the brain.
  - (ii) Controls voluntary functions.
  - (iii) Serves to remember information.
  - (iv) To collect and coordinate information from different parts of the body.
  - (v) Center related to hunger.
- (b) **Middle brain:** Controlling involuntary actions. For example - change in the size of the pupil. Reflex action of head, neck etc.

- (c) **Human brain** : It has three parts :
- (i) **Cerebellar**: Body positioning and balance, precision of voluntary actions, eg: lifting of legs.
  - (ii) **Medulla**: Control of involuntary functions like blood pressure, vomiting etc.
  - (iii) **Pons**: Control of involuntary functions like breathing.

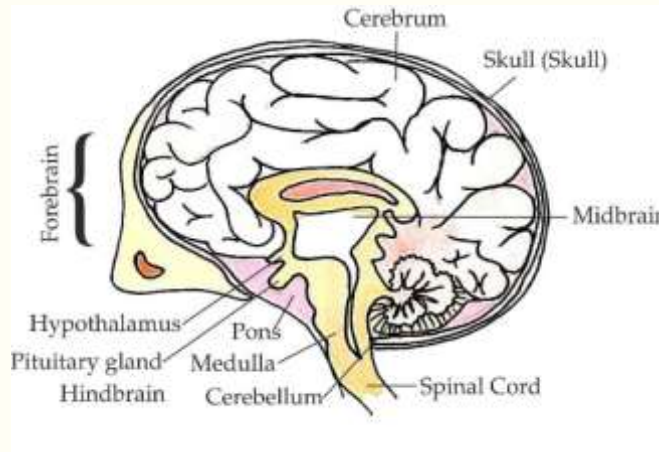
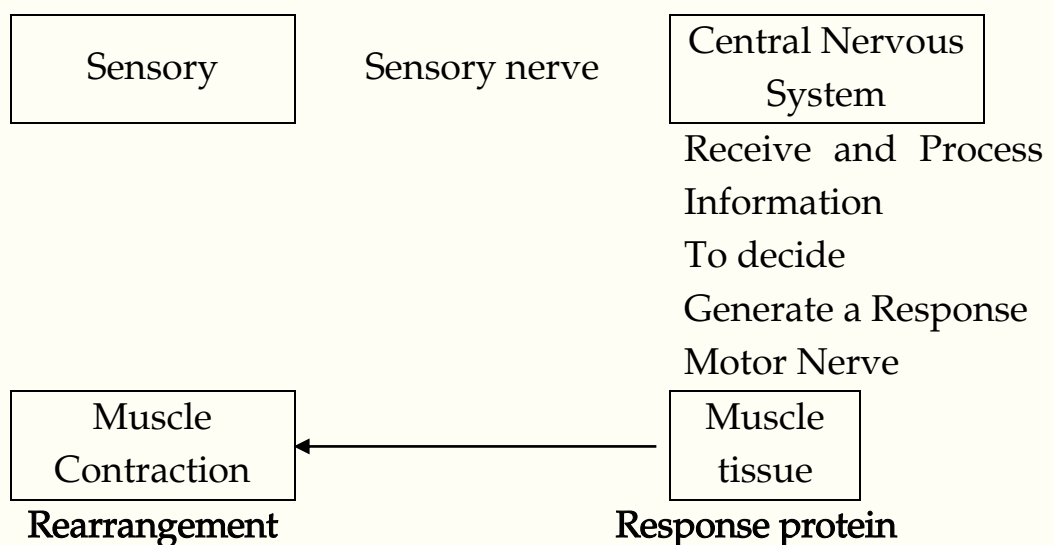

Fig . 5.2

### Brain and spinal cord protection

- (a) **Brain** : The brain is located in a box of bones. Inside the box is the brain in a fluid-filled balloon that acts as a shock absorber.
- (b) **Spinal cord**: The spinal cord is protected by the vertebral column or spinal cord.

### Coordination between nervous tissue and muscle tissue



Limitation of electrical signal or nervous system:

- (i) The electrical impulse can reach only those cells which are connected to the nervous system.
- (ii) Once an electrical impulse has been generated, the cell takes time to adjust its functioning before generating a new impulse. Hence the cell cannot generate impulses continuously.
- (iii) There is no nervous system in plants.

**Chemical Transmission:** Chemical transmission began to be used to overcome the limitations of electrical transmission.

### Coordination in plants

Movement in plants:

- (i) Growth is not dependent on movement.
- (ii) Speed dependent on growth.
- (i) **Immediate response to stimulus :**
  - Not dependent on growth.
  - Plants transmit information from one cell to another using electro-chemical means.
  - Generates movement by changing the amount of water present inside it, due to which the cell shrinks.

**Example:** Shrinking of the leaves of the six-leaved plant when touched.

- (ii) **Movement due to growth :** These follow-up movements are due to stimuli.
  - of the tentacle that is away from the object moves faster than the part near the object, due to which the tentacle wraps around the object.
  - **Phototropism:** Movement towards light.
  - **Gravitational motion:** motion toward or away from the Earth.
  - **Chemotropy:** Movement of the pollen tube towards the ovary.
  - **Hydrotropy:** Movement of roots towards water.

**Plant Hormones:** These are the chemicals that coordinate the growth, development and response of plants. Plant hormones are found in plants.

**The main plant hormones are:**

- (a) **Auxin :**
  - (i) Formed on the tip of the branches.
  - (ii) To increase the length of the cell.
  - (iii) Aids in phototropism.
- (b) **Gibberellin :**
  - (i) Helps in growth of stem.
- (c) **Cytokinin :**
  - (i) Cell divides rapidly.
  - (ii) It is found in abundance in fruits and seeds.
- (d) **Absciscic acid :**
  - (i) Growth inhibition.
  - (ii) Withering of leaves.
  - (iii) Stress hormone.

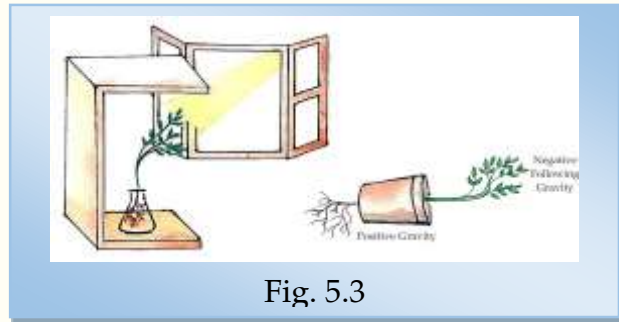

### Hormones in animals

Coordinate the activities, growth and development of animals .

**Endocrine Glands:** These are the glands which secrete their products into the blood, which are called hormones.

### Iodized salt is essential:

The thyroid gland needs iodine to make thyroxine hormone. Thyroxine controls the metabolism of carbohydrates, fats and proteins, so that the balanced growth of the body can be achieved. Therefore, iodine is required for the proper functioning of the thyroid gland. Throat swells due to iodine deficiency, which is called goiter disease.

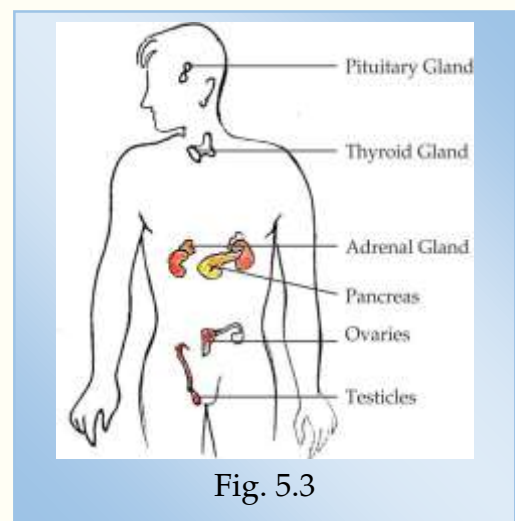

**Diabetes (Diabetes):** In this disease the level of sugar in the blood increases.

**Cause:** It is due to deficiency of insulin hormone secreted by the pancreas gland. Insulin controls the level of sugar in the blood.

**Diagnosis (Treatment):** Injection of insulin hormone.

**Recharge Mechanism:** Excess or undersecretion of hormones has harmful effects on our body. The feedback mechanism ensures that the hormone is secreted in the right amount and at the right time.

**For example:** method of controlling sugar in the blood.

### Practice Work

Q. 1. Select the correct option -

- (1) Goitre disease occurs -
  - (a) Due to lack of blood
  - (b) Due to lack of sugar
  - (c) Deficiency of Iodine
  - (d) None of these
- (2) Thyroxine hormone is secreted by -
  - (a) liver
  - (b) kidney
  - (c) Testis
  - (d) Thyroid
- (3) Which of the following is a plant hormone?
  - (a) Thyroxine
  - (b) Estrogen
  - (c) Cytokinin
  - (d) Insulin

Q. 2. Fill in the blanks -

- (1) The sensory organ for receiving sound in living beings is .....
- (2) ..... hormone is secreted by the pancreatic gland.
- (3) The empty space between two nerve cells is called .....

Q. 3. Mark True (✓) or False (✗) against the following statements.

- (1) An increase in the level of sugar in the blood can lead to diabetes.
- (2) The brain is the center of coordination of all activities.

- (3) Neuron is the structural and functional unit of the nervous system.

Q. 4. Match the correct pair.

Column 'A'	Column 'B'
(1) Adrenal gland	a) Testosterone hormone
(2) Ovary gland	b) Growth hormone
(3) Pituitary gland	c) Estrogen hormone
(4) Testicular gland	d) Adrenaline hormone

Q. 5. Very short answer type questions -

- (1) Name the structural and functional unit of the nervous system.
- (2) Which type of action is the removal of hands after touching a hot object?
- (3) Which gland is called master gland.

Q. 6. Short Answer Type Questions -

- (a) What is hormone?
- (b) Draw the structure of the nervous system and write its functions.
- (c) How does coordination take place in plants?

Q. 7. Long answer type questions -

- (a) Name the hormones secreted by the endocrine glands and write their functions.

## Chapter - 6

### Different Phenomena of light

Dear students! You must have seen many surprising incidents in daily life like - the size of the teeth appearing larger than the actual size in the dentist's mirror, the small size of the car coming from your vehicle in the mirror of your vehicle, picking up a coin dipped in water, Formation of rainbow after rain etc. In this chapter, we will study various phenomena of light.

#### Reflection of light by a spherical mirror

##### Spherical mirror

A spherical mirror is formed when a hollow sphere of glass is cut. A coating of silver material is applied on one surface of the spherical mirror and the other surface acts as a reflector. Spherical mirrors are of two types - (1) Convex mirror, (2) Concave mirror

(1) **Convex mirror** - When light is reflected from the convex surface of the spherical mirror and the concave part is coated. is called a convex mirror.

The image of an object placed at infinity in front of a convex mirror is formed at the focus behind the mirror.

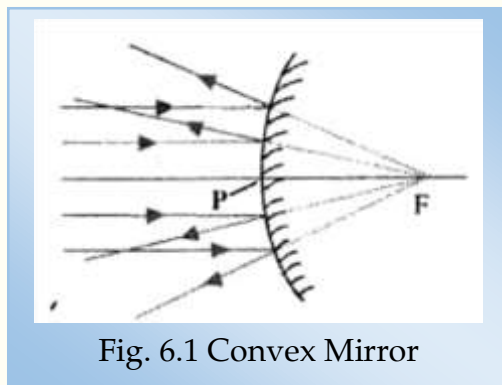

Fig. 6.1 Convex Mirror

**Pole** - The center of the reflecting surface of a spherical mirror is called the pole (P) of the mirror.

is called the center of curvature (C) of the spherical mirror .

**Radius of curvature** - The distance from the pole to the center of the mirror is called radius of curvature (R) .

**Principal Axis:** The line passing through the pole and the center of curvature of a spherical mirror is called the principal axis.

**Principal focus** - The light rays coming parallel to the principal axis of the spherical mirror converge at the point on the principal axis after reflection. We call that point the principal focus (F) of the mirror.

**Focal length (F)** - The distance between the pole (P) and the principal focus (F) of the mirror is called focal length (f). The focal length is half the radius of curvature.

$$f = \frac{R}{2}$$

**Uses of Convex Mirror** - Convex mirrors form an erect and smaller image than the size of the object. Convex mirrors are used as side mirrors of vehicles. With the help of this mirror, the vehicle driver can see the vehicles coming behind him.

(2) **Concave mirror** - When light is reflected from the concave surface of a spherical mirror, that is, when the inwardly curved part of the spherical mirror acts as a reflecting surface and the convex part of the mirror is coated, then this mirror is called concave mirror. The image of an object placed at infinity in front of a concave mirror is formed at the principal focus.

**Uses of Concave Mirror** - Concave mirrors are used for headlights of vehicles, torches, searchlights, shaving mirrors to see enlarged images of faces and are used by dentists to see enlarged images of patients' teeth.

### **Refraction of light -**

When a light ray enters from one medium to another, it deviates from its path. This phenomenon of light is called refraction of light.

### **Examples of the phenomenon of refraction of light -**

- (1) A rope or rod immersed in water appears bent.
- (2) A coin immersed in water appears to be raised slightly above its actual depth.

### **law of refraction of light**

- (1) The incident ray, the refracted ray and the normal all three should lie in the same plane.



- (2) The ratio of the sine of the angle of incidence to the sine of the angle of refraction should be fixed.

$$\frac{\sin i}{\sin r} = \text{constant}$$

(This law is also known as Snell's law of refraction.)

Now we will understand some points related to the phenomenon of refraction of light -

(1) **Dense medium** - When the particles of a medium are located very close to each other, then that medium is called a dense medium. eg. - On comparing solid, liquid and gas, solid will be denser medium.

(2) **Rarer medium** - When the particles of a medium are located far away from each other, then that medium is called rarer medium. eg. - On comparing solid, liquid and gas, gas will be a rare medium.

- When a light ray enters from a denser medium to a rarer medium, it deviates away from the normal.
- When a light ray enters from a rarer medium to a denser medium, it bends towards the normal.

### Refraction of light through a prism

A ray of light is refracted twice when it passes through a prism. Monochromatic light RQ is incident on the side AB of the prism, this light is refracted in the direction QS and incident on the side AC of the prism. Light is refracted again in ST direction, thus light is refracted twice.

**Angle of deviation** - Due to the special shape of the prism, the emergent ray deviates in the direction of the incident ray and forms an angle called the angle of deviation ( d ) .

### Dispersion of white light by a glass prism

When white light passes through a transparent medium (prism), it splits into seven different colors, this phenomenon of light is called dispersion of light. As a result of the phenomenon of dispersion of light, a spectrum of seven colors is obtained on the screen, which are as follows-

V to Violet  
 I to Indigo  
 B to Blue  
**VIBGYOR**  
 G to Green  
 Y to Yellow  
 O to Orange  
 R to Red

### Formation of rainbow

Rainbow is formed due to the combined phenomenon of reflection, refraction and deflection of light by the microscopic drops of water present in the atmosphere. A rainbow is always formed in the opposite direction to the Sun.

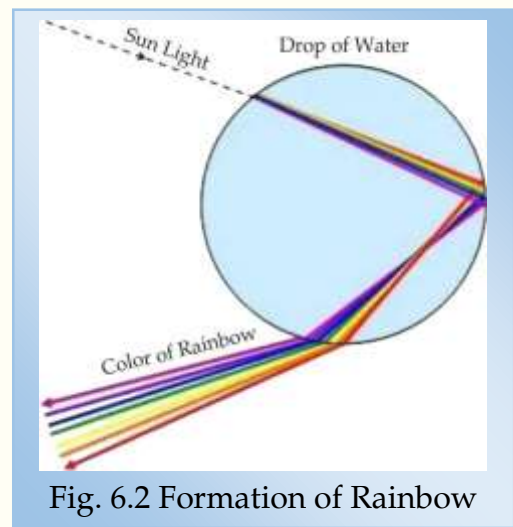
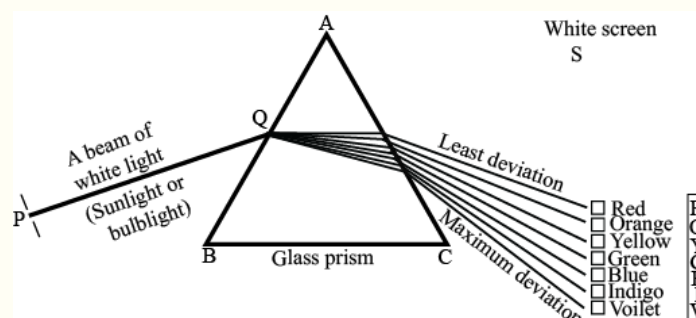

Fig. 6.2 Formation of Rainbow

In this phenomenon of light, the small drop of water acts like a prism. When the sunlight falls on the drops of water, it is first refracted and deflected.

After that it becomes completely internal reflected. Sunlight refracts when it comes out of the water droplets to form a rainbow.



सूर्यस्य विविधवर्णाः पवनेन विघट्टिताः कराः साभ्रे ।  
वियति धनुसंस्थाना ये दृश्यन्ते तदिन्द्रधनुः ॥

(बृहत्संहिता 35.1)

In this shloka of Brihatsamhita, the form of rainbow has been mentioned. Sun rays collide with the air in the cloudy sky and split into different colors to form a multi-colored arched shape called a rainbow.

Seven rays of the sun and seven colors

यं सीमकृण्वन् तमसे विपृचे ध्रुवक्षेमा अनवस्यन्तो अर्थम् ।  
तं सूर्यं हरितः सप्त यहीः स्पर्शं विश्वस्य जगतो वहन्ति ॥

(ऋग्वेद - 4/13/3)

The one who remains stable at his place and does not give up his work and dispels the darkness all around was created by the Gods, there are seven great horses / Rashis of the Sun who see the whole world.

अव दिवस्तारयन्ति सप्त सूर्यस्य रश्मयः । (अथर्ववेद – 7.107.1)

The seven rays of the sun bring down the ocean currents from heaven. Seven rays and seven colors of the Sun have been seen in the above Veda mantras seen by sages. Which are known as seven colors in modern science. Like – Violet, Indigo, Blue, Green, Yellow, Orange, Red

From the subtle study of these mantras, it is known that the white light of the Sun is a combination of seven rays (colours) together. Refraction of light passing through water points, total internal reflection, dispersion of colors results in the formation of a rainbow in which white light is divided into seven colours.





Fig. 6.3 - The white rays of the sun as seen from the earth and the seven colors of the rainbow made of sun rays

### Total internal reflection

When a ray of light passes from a denser medium to a rarer medium, it deviates away from the normal. On increasing the value of angle of incidence, the value of angle of refraction also increases, when the value of angle of refraction is greater than the critical angle ( $90^\circ$ ) on increasing the value of angle of incidence, the light ray returns back through the same medium. is called reflection.

### Examples of phenomenon of total internal reflection -

1. Shining of Diamond.
2. Feeling of mirage or false water in the desert.
3. Transmission of light signals over long distances in an optical fibre.

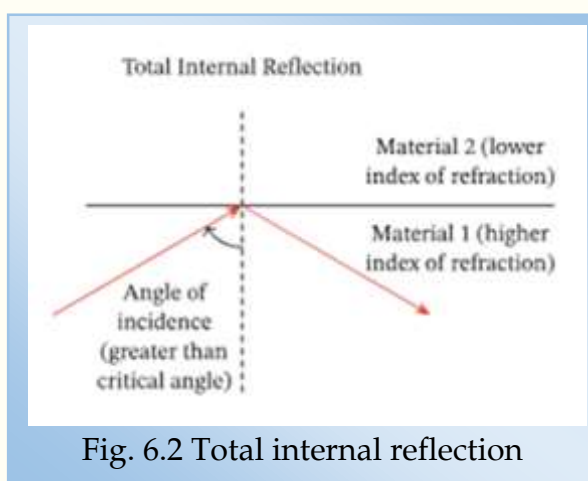

Fig. 6.2 Total internal reflection

### Critical angle -

When a ray of light is entering from a denser medium to a rarer medium, then the angle of incidence is the value at which the angle of refraction becomes 90 degrees, then it is called the critical angle.

## Scattering of light -

When a ray of light passes through a medium in which microscopic particles of dust and other substances are present, then light is transmitted in all directions by these microscopic particles, this phenomenon of light is called scattering of light.

Some examples of scattering phenomenon of light -

1. The color of the sky appears blue.
2. At the time of sunrise and sunset, the color of the sun appears red.

## Practice Work -

### Q. 1. Multiple Choice Questions -

- (1) The shining of a diamond is an example of which phenomenon of light?  
(a) Refraction                      (b) Deflection  
(c) Scattering                      (d) Total internal reflection
- (2) The formation of a rainbow is an example of which phenomenon of light -  
(a) Dispersion                      (b) Reflection  
(c) Refraction                      (d) Scattering
- (3) A rod immersed in water appears to be bent due to which phenomenon of light?  
(a) Reflection                      (b) Refraction  
(c) Scattering                      (d) Dispersion

### Q. 2. Fill in the blanks -

- (1) ..... mirrors are used in the side mirrors of vehicles.
- (2) ..... mirrors are used by dentists.
- (3) The focal length of a spherical mirror is ..... of the radius of curvature.

### Q. 3. Mark True (✓) or False (✗) against the following statements.

- (1) A convex mirror forms an image smaller than the size of the object.
- (2) Rainbow is always formed in the opposite direction of the Sun.
- (3) The color of the sky appears blue due to the scattering of light.

### Q. 4. Match the correct pair.

Column 'A'

Column 'B'

- |                    |                     |
|--------------------|---------------------|
| (1) Convex mirrors | a) used by dentists |
|--------------------|---------------------|

- (2) Concave mirrors
- (3) Formation of mirage in the desert
- (4) Reddish appearance of the sun at sunrise
- b) Use in side mirrors of vehicles
- c) Scattering of light
- d) Total internal reflection

Q. 5. Very short answer type questions

- (1) How many types of spherical mirrors are there ?

Q. 6. Short Answer Type Questions

- (1) What is the use of a convex mirror ?
- (2) What is refraction of light ?
- (3) Explain the phenomenon of dispersion of white light by a glass prism.

Q. 7. Long Answer Type Questions

- (1) What is total internal reflection ? Explain with examples.

## Chapter - 7

### Human eye and colorful world

Dear students ! In this chapter, we will study the phenomenon of refraction of light by spherical lenses and understand the working of human eye and how to correct the defects of vision.

#### Spherical lens

Any transparent medium bounded by two surfaces of which one or both the surfaces are spherical is called a lens .

#### Refraction by Spherical Lenses -

##### Refraction by a convex lens

Appear thin at the edges and thick in the middle are called convex lenses. That is, they are made up of two raised pages. It collects the incident light. That is, they converge, hence they are also called converging lenses.

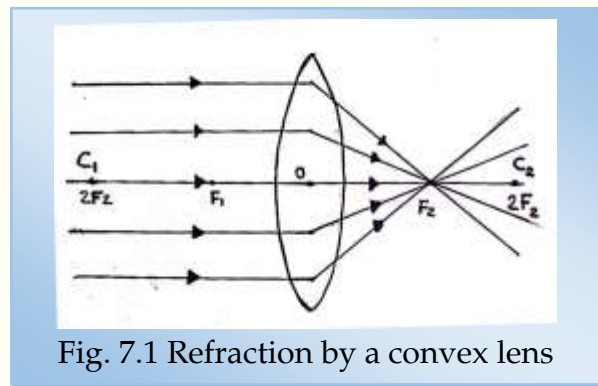

Fig. 7.1 Refraction by a convex lens

##### Refraction by concave lens :-

Such lenses are thicker from the edges and thinner from the middle, when light is incident on these lenses, they spread the light. That is, they diverge, they are called concave lenses.

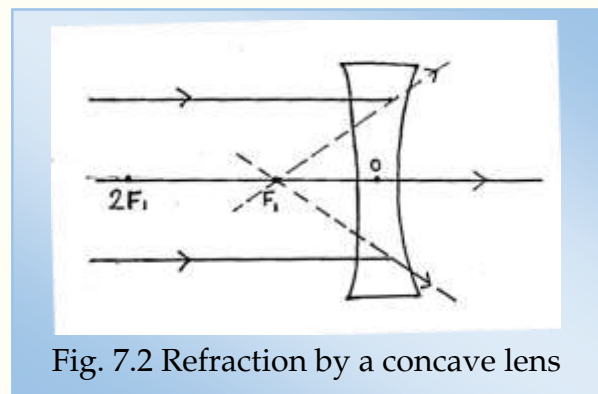

Fig. 7.2 Refraction by a concave lens

#### Human eye

The functioning of the human eye is similar to that of a state-of-the-art autofocus camera. Eye about 2.3 cm. A circular organ of diameter whose main part is as follows.

1. **The sclera** – There is an opaque white protective shield around the eye which is called the sclera.



2. **Cornea** – There is a transparent slightly raised part in the center of the sclera in front of the eye, which is called the cornea. Rays of light refract from this part and enter the eye.

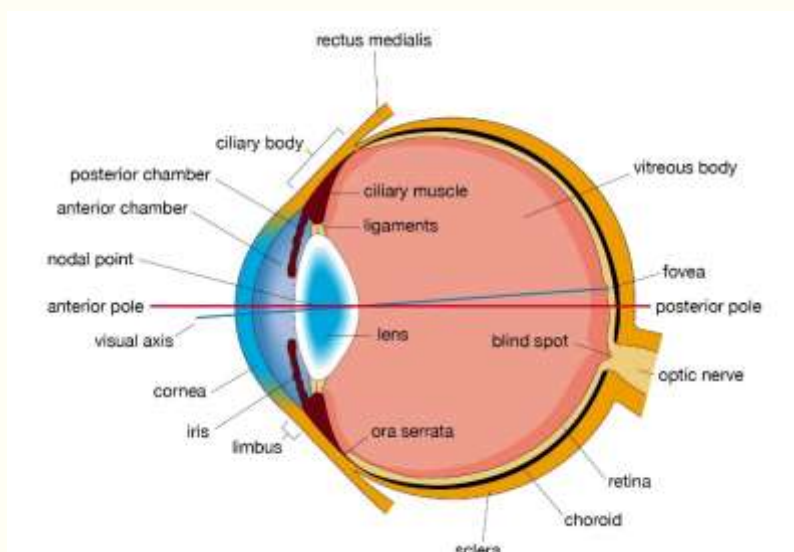

Fig. 7.3 Human Eye Structure

3. **Iris** – It is an opaque muscular structure behind the cornea with a hole in the middle. Its color is mostly black.
4. **Pupil** – The hole in the middle of the iris is called pupil. The muscles of the iris work to control the size of the pupil according to the amount of light entering the pupil. That is, in bright light the size of the pupil becomes small and in dim light the size of the pupil becomes large.
5. **Eye lens** – Behind the iris, there is a lens of flexible transparent substance which remains in its place with the help of muscles. The pressure of the muscles causes a small change in the radius of curvature of this lens to focus the refracted rays from the cornea onto the retina. The image formed by this is small, inverted and real.
6. **Retinal** - There is a transparent membrane under the retinal, which is called retinal. The light rays coming from the object are refracted by the cornea and eye lens and focus on the retina. There are many photosensitive cells in the retina, which generate electrical signals as soon as light is received. Electrical signals generated from the retina are sent to the brain by the optic nerve. The brain makes a proper combination of this inverted image and shows it straight to us.

## चक्षुरसि चक्षुर्मे दाः स्वाहा ।

(अथर्व. 2.17.6)

In this mantra of Atharvaveda, Agnidev has been requested to grant Chakshu (eye) i.e. the power to see.

Near point the minimum distance from where the object can be seen clearly is called the near point of the eye. For normal vision, the distance of the near point from the eye is about 25 cm.

**Far Point** - The maximum distance from the eye up to which the object can be seen clearly is called the far point of the eye. This distance of normal eyes is infinite.

### Vision defects and their correction -

Due to loss of accommodation capacity by the eye, the person is not able to see the objects clearly. This phenomenon is called vision defect.

Visual defects can be corrected with the help of spherical lenses -

### There are mainly three vision defects –

1. A person suffering from myopia can see near objects clearly but distant objects appear blurred. The main reason for this vision defect is the increase in the curvature radius of the eye lens. The image of objects kept away from the eye of the person suffering from this defect is formed before the retina. The far point of such a defective person instead of being at infinity, comes closer to the eye. This defect is corrected by using a concave lens of suitable power. A concave lens diverges parallel rays coming from an object at infinity. So that those rays

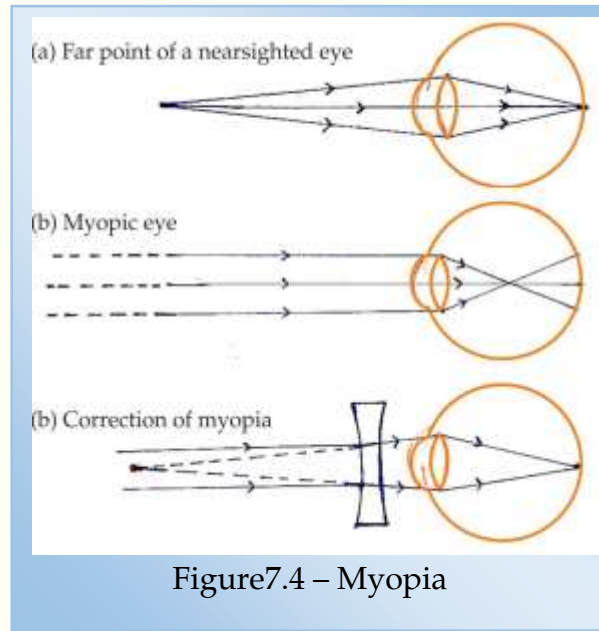

appear to be coming from a point which is the farthest point for the defective eye to see clearly.

## 2. long sightedness

A person suffering from farsightedness can see distant objects clearly, but nearby objects cannot be seen clearly. The near point of a person suffering from farsightedness becomes distant. This defect is corrected by using a convex lens of suitable power.

### 3) A little foresight -

With increasing age, due to the decrease in the flexibility of the eye lens and muscles, the accommodation capacity of the eye decreases. Because of this, the victim cannot see nearby objects. Many times with age one cannot see near objects as well as distant objects. This defect is called short sightedness. Bi-focus lenses are used to prevent this disease.

Cataracts - Due to old age, the crystalline lens of the eye of some people becomes milky and cloudy, this condition is called Cataract. Due to this disease, there is a decrease in the vision of the eye or there is complete loss of vision.

This disease can be treated by surgery.

**Atmospheric Refraction** - The change in the refractive index of waves or rays of light due to the difference in altitude in atmospheric density is called atmospheric refraction.

1. **Twinkling of the stars** - The rays of light coming from the stars are refracted several times by the atmospheric layers in order to reach the earth, due to which the path of the light rays keeps on changing. Because of this we see the stars twinkling.

2. **Advance sunrise and delayed sunset** - Due to the refraction of the rays coming from the sun, the sun becomes visible a little before the

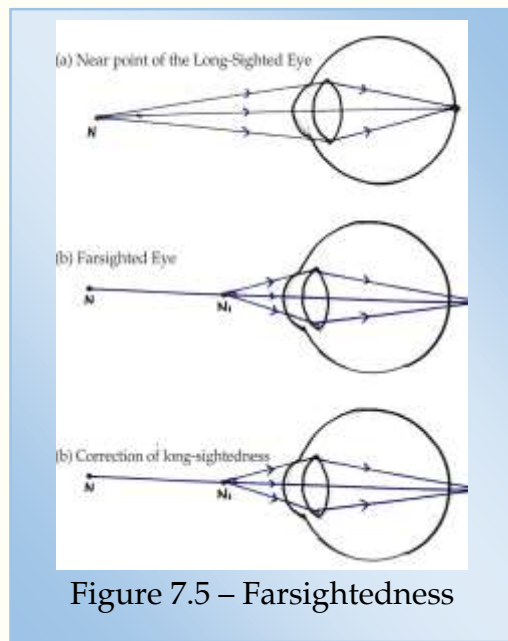

Figure 7.5 – Farsightedness

---

sunrise, it is called advance sunrise. The rays of light coming from the Sun get bent towards the normal when they enter the Earth's atmosphere. Due to which the sun appears slightly above its actual position, hence the sun is visible till about 2 minutes after sunset.

3. **The sky appears blue** - the atmosphere consists of air particles and other microscopic particles. These particles scatter blue color and light of shorter wavelength more than the light of the wavelength of visible light, due to which the color of the sky appears blue.



## Practice Work

### Q. 1. Multiple Choice Questions -

- (1) Most of the refraction of light rays entering the eye takes place from which part of the eye?  
(a) Iris            (b) Cornea            (c) pupil            (d) retina
- (2) The distance of the near point from the eye for normal vision is -  
(a) 20 cm            (b) 25 cm            (c) 30 cm            (d) 15 cm
- (3) The opaque protective shield found around the eye is called –  
(a) iris            (b) pupil            (c) cornea            (d) sclera

### Q. 2. Fill in the blanks -

- (1) The transparent medium surrounded by two surfaces is called .....
- (2) Convex lens is also called ..... lens.
- (3) The color of the sky appears blue due to the phenomenon of light.
- (4) A person suffering from myopia cannot see .....

### Q. 3. Mark True (✓) or False (✗) against the following statements.

- (1) Convex lens is also called converging lens.
- (2) When the accommodation capacity of the eye is over, the person cannot see the objects clearly.
- (3) Cataract usually occurs in old age.

### Q. 4. Match the correct pair.

- | Column 'A'                            | Column 'B'                |
|---------------------------------------|---------------------------|
| (1) Twinkling of stars                | a) Scattering of light    |
| (2) The color of the sky appears blue | b) Atmospheric refraction |
| (3) Myopia                            | c) Convex lens            |
| (4) Farsightedness                    | d) Concave lens           |

Q. 5. Very short answer type questions –

(1) Which lens is used in myopia.

Q. 6. Short answer type questions -

(1) What is Cataract ?

(2) What is farsightedness ? How is it resolved ?

(3) Explain the structure of human eye with diagram.

(4) Why do stars appear to be twinkling ?

(5) Why does the sun appear red at the time of sunrise?

Q. 7. Long Answer Type Questions

Explain the working of human eye.



## Chapter - 8

### Electric current

The way heat flows from an object of higher temperature to an object of lower temperature. The rate of heat flow is called heat current, similarly the flow of charge in a conducting wire from high potential point to low potential point and the rate of flow of charges is called electric current. The direction of electric current is from positive charge to negative charge. That is, the direction of motion of electrons is opposite.

#### 8.1 Electric current

“ The amount of charge passing through a point in unit time in any electric circuit is called electric current.” Or “The rate of flow of charges is called electric current.” Let a charge  $Q$  pass through a point in time  $t$ , then

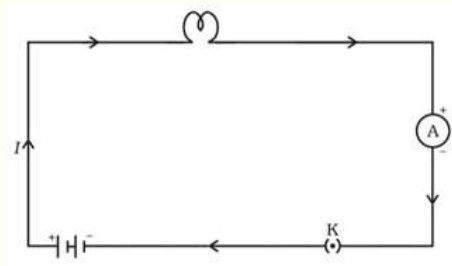

$$\text{Electric current} = \frac{\text{Charge}}{\text{Time}}$$

$$I = \frac{Q}{t}$$

$n$  electrons pass through a point in an electric circuit in time  $t$ , then the charge will pass through that point in time  $t$ , so

$$\text{Electric current (I)} = \frac{ne}{t}$$

where  $e$  is the charge on the electron, which has a value of  $1.6 \times 10^{-19}$  coulombs.

#### 8.2 Unit of electric current

from the formula of electric current

$$I = \frac{ne}{t} \quad \text{Unit of } I = \frac{\text{coulomb}}{\text{second}} = \text{ampere}$$

Following are some units of electric current

$$1 \text{ milliampere} = 10^{-3} \text{ ampere}$$

$$1 \text{ micro ampere} = 10^{-6} \text{ ampere}$$

Definition of an ampere -

If  $Q = 1$  coulomb and  $t = 1$  second,

$$I = \frac{1}{1} = 1 \text{ ampere}$$

“If 1 Coulomb charge passes through a point in an electric circuit in 1 second, the current in that circuit will be one ampere.”

An ammeter is used to measure electric current. It is placed in series in the circuit.

**Example 1** Find the number of electrons in a coulomb charge ?

$$\begin{aligned} Q &= ne \\ &= 1n \times 1.6 \times 10^{-19} \\ n &= \frac{1}{1.6 \times 10^{-19}} \\ n &= \frac{10^{19}}{1.6} = \frac{10 \times 10^{18}}{1.6} = 6.25 \times 10^{18} \end{aligned}$$

### 8.3 Potential and Potential Difference

Electric potential describes the direction of electric current through a charged object. When two charged objects are placed in contact with each other, the positive charge always flows from the object of higher potential to the object of lower potential. If the potential on both the objects is same. That is, the potential difference (potential difference) is zero and these two objects are in a state of electrical contact, then no charge or current will flow between them.

We define the electric potential difference between two points of a current carrying electric circuit by work. “The work done in moving a unit positive charge from one point to another in an electric circuit is equal to the potential difference between those two points .

Potential difference between two points A and B

$$(V_A - V_B) = \frac{\text{Work done (W)}}{\text{Charge (Q)}} \quad V_A - V_B = \frac{W}{Q} \text{Unit} \frac{\text{Joule}}{\text{Coulomb}} = \text{Volt}$$

#### Electric potential

If B is infinite  $\infty$  But obey



$$V_A - V_\infty = \frac{W}{Q}$$

Potential at infinity is assumed to be zero  $V_A = \frac{W}{Q}$

If  $Q = 1$  ( unit) then  $V_A = W$

“ The electric potential at a point is equal to the work done in bringing unit positive charge from infinity to that point. ” The instrument used to measure the potential difference is called a volt meter, the two points between which the potential difference is to be measured. . The volt meter is placed in parallel to those points.

Example 2 How much work is done in moving a charge of 3 coulombs between two points of potential difference 10 V?

$$\text{Formula } V_A - V_B = \frac{W}{Q} \quad V_A - V_B = 10 \text{ V}$$

$$W = (V_A - V_B) \times Q \quad Q = 3 \text{ coulombs}$$

$$W = 10 \times 3 \text{ W} = ?$$

$$W = 30 \text{ joules}$$

#### 8.4 Common symbols of useful devices in electrical circuits

Various components are denoted by convenient symbols for drawing diagrams of electrical circuits, which are given in the table.

Table 8.1

Sl.No.	Component	Symbol
1.	Electric cell (battery)	
2.	Plug key or switch	
3.	Voltmeter	
5	Ammeter	
6	Resistor	

Table 7.1 Symbols to represent some of the commonly used electrical components -

Ohm 's law: In an electric circuit, the potential difference between the two ends of a metal wire is proportional to the current flowing through it, but the temperature of the wire should remain the same.

$$V \propto R$$

$$V = IR$$

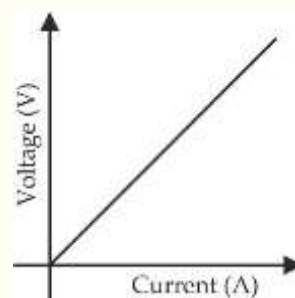

R is a constant called the resistance of the wire.

**Resistance:** It is the property of a conductor due to which it opposes the flow of current. The SI unit is the Ohm ( $\Omega$ ).

$$1 \text{ ohm} = \frac{1 \text{ volt}}{1 \text{ ampere}}$$

1 ampere is flowing through the circuit and the potential difference is of one volt, then the resistance is called 1 ohm.

**Current Regulator:** The device which is used to change the resistance in the circuit is called current regulator.

**Factors on which the resistance of a conductor depends:**

- (i) Is proportional to the length of the conductor.
- (ii) Inversely proportional to the area of cross-section.
- (iii) Is proportional to temperature.
- (iv) Also depends on the nature of the substance.

**Electrical Resistivity:** The resistance produced when a current passes through opposite faces of a cube of side 1 m is called resistivity.

**SI unit  $\Omega \text{ m}$  ( ohm meter) -**

- Resistivity does not change with the length and area of cross-section of the conductor but it does with temperature.
- Resistivity range of metals and alloys -  $10^{-8} - 10^{-6} \Omega \text{m}$  it occurs.
- The resistivity of alloys is relatively higher than that of their constituent metals.
- Alloys do not oxidise (combust) quickly at high temperature, hence they are used in heating devices.

- Copper and aluminum are used for electricity transmission because of their low resistivity.

### Series combination of resistors:

When two or three resistors are connected end to end, the combination is called a series combination.

Total impressed resistance in series order -

$$R_S = R_1 + R_2 + R_3$$

An equal current flows through each resistor.

And total potential difference = sum of potential difference of individual resistors.

$$V = V_1 + V_2 + V_3$$

$$V_1 = IR_1, V_2 = IR_2, V_3 = IR_3$$

$$V_1 + V_2 + V_3 = IR_1 + IR_2 + IR_3$$

$$V = I(R_1 + R_2 + R_3) \quad (V_1 + V_2 + V_3 = V)$$

$$IR = I(R_1 + R_2 + R_3)$$

$$R = (R_1 + R_2 + R_3)$$

Hence the single equivalent resistance is greater than the largest individual resistance.

### Resistors connected in parallel

The potential difference across each resistor in parallel is equal to the applied potential difference. And the total current is equal to the sum of the currents passing through each individual resistor.

$$I = I_1 + I_2 + I_3$$

$$\frac{V}{R} = \frac{V}{R_1} + \frac{V}{R_2} + \frac{V}{R_3}$$

$$\frac{1}{R} = \frac{1}{R_1} + \frac{1}{R_2} + \frac{1}{R_3}$$

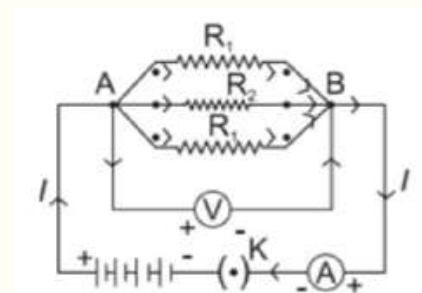
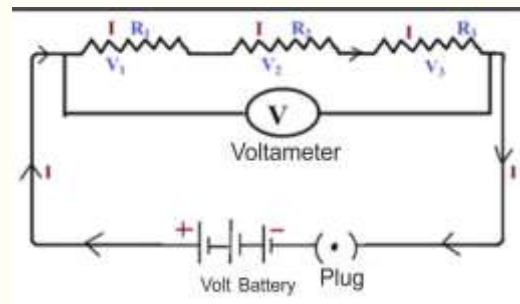

A single equivalent resistance is equal to the sum of the reciprocals of the resistances.

Advantages of parallel combination over series combination -

- (1) In a series combination, when one component fails, the circuit breaks down and none of the components work.
- (2) Different components require different current, this property is not suitable in series order because the current remains same in series order.
- (3) Resistance is less in parallel combination.

### Heating effect of electric current

If an electric circuit is purely resistive, then the energy of the source is completely dissipated in the form of heat, this is called the heating effect of the electric current.

$$\text{energy} = \text{power} \times \text{time}$$

$$H = P \times t$$

$$H = VIt \quad P = VI$$

$$H = I^2Rt \quad V = IR \quad H = \text{heat energy}$$

$$\text{Hence energy (heat) produced} = I^2Rt$$

### Joule's law of heating of electric current:

According to this rule:

- (1) The heat generated in a resistance is proportional to the square of the current flowing through it.
- (2) Is proportional to the resistance.
- (3) Is proportional to the time for which the current flows.

Is desirable in heaters, presses etc. but undesirable in computers, mobiles etc.

In the electric bulb, most of the power appears in the form of heat and some part is emitted in the form of light.

The filament of electric bulb is made of tungsten because -

- (1) It is not oxidised at high temperature.
- (2) Its melting point is high (3380°C).
- (3) Chemically inert nitrogen and argon gas are filled in the bulbs, which increases the life of the fiber.

**Electric power:** The rate at which work is done when current flows in an electric circuit is called electric power. The symbol is

$$P = VI$$

$$P = I^2R \quad I = \frac{V}{R}$$

$$P = \frac{V^2}{R}$$

The SI unit of power is = watt.

1 watt 1 volt × 1 ampere

practical unit of energy = kilowatt hour

= kWh

1 kWh =  $3.6 \times 10^6$  J

1 kWh = a unit of electrical energy

## Practice Work

### Q. 1. Multiple Choice Questions -

- (1) Whose unit is Volt?
  - (a) Current
  - (b) Potential difference
  - (c) Charge
  - (d) Work
- (2) It is not a device based on the heating effect of electricity.
  - (a) Heater
  - (b) Press
  - (c) Tester
  - (d) Refrigerator
- (3) The SI unit of resistance is –
  - (a) ohm
  - (b) ohm × meter
  - (c) Ampere
  - (d) Watt

### Q. 2. Fill in the blanks –

- (1) There are .....watts in 1 horse power.
- (2) The measurement of potential difference is done in a voltmeter instrument.
- (3) The resistance of a wire is ..... of its length.

### Q. 3. Mark True (✓) or False (✗) against the following statements.

- (1) Pure water is a poor conductor of electricity.
- (2) The rate of doing work is called power.
- (3) The filament of electric bulb is made of tungsten metal.

### Q. 4. Match the correct pair.

- | Column 'A'                            | Column 'B'  |
|---------------------------------------|---|
| (1) Electric current                  | (a) ohm × meter   |
| (2) Resistivity                       | (b) ampere  |
| (3) Series combination of resistors   | (c) $\frac{1}{R} = \frac{1}{R_1} + \frac{1}{R_2} + \frac{1}{R_3}$ |
| (4) Parallel combination of resistors | (d) $R = R_1 + R_2 + R_3$   |

Q. 5. Very short answer type questions

- (1) Write the name of that device? Which helps in maintaining the potential difference across the ends of a conductor.

Q. 6. Short answer type questions -

- (1) Give the definition of electric current.
- (2) What is called electric potential?
- (3) Explain series combination and parallel combination of resistor.

Q. 7. Long answer type questions -

- (1) Write Ohm's law.
- (2) In how many ways can three identical resistances be connected?
- (3) Tell the value of the resistor when three resistors of 3 Ohm are connected in series and parallel.
- (4) kWh And write the relation in joules.
- (5) An electric bulb is connected to a 110 V generator. If 0.40 A current flows through the bulb, then what will be the power of the electric bulb ?
- (6) A washing machine of 100 W is allowed to run for 2 hours/day. Rs 8 per kWh What will be the cost of energy to run for 30 days at the rate of Rs .

## Chapter - 9

### Magnetic Effect of Electric Current

Dear students! In the previous chapter, we studied about the heating effect of electric current. In this chapter, we will study about the magnetic effect of electric current.

A magnet is a substance that attracts iron and iron-containing substances towards itself.

#### Properties of Magnet:

- (1) Every magnet has two poles - North pole and south pole.
- (2) Like poles repel each other.
- (3) Unlike poles attract each other.
- (4) A freely suspended magnet rests approximately in the north-south direction, with the north pole pointing north and the south pole pointing south.



**Magnetic field:** The region around a magnet in which the force of the magnet is detected.

The SI unit is the Tesla.

Magnetic field has both magnitude and quantity. The magnetic field can be explained with the help of compass.

The needle of a compass is a freely suspended bar magnet.

**Properties of magnetic field lines:** Field lines appear from the North Pole and merge at the South Pole.

- Field lines are closed curves.
- The lines are closer together in a strong magnetic field.
- Two lines do not intersect each other anywhere because if they intersect then it means that there are two directions at a point which is not possible.



- The strength of the magnetic field is given by the degree of closeness of the field lines.

### **Magnetic field of a bar magnet:**

Hans Christian Oestend was the first person to discover that an electric current produces a magnetic field.

**Dakshin (right) hand thumb rule:** Imagine that you are holding a current carrying conductor in your right hand in such a way that your thumb points towards the current, then your fingers will show the direction of the magnetic field around the conductor.

### **Magnetic field due to current flowing through a straight conductor**

1. The magnetic field at any point on the conductor can be represented by concentric circles.
2. The direction of the magnetic field can be given by right hand thumb rule or compass.
3. The circles near the conductor are close together.
4. Magnetic field  $\propto$  Stream Did Power.
5. Magnetic field  $\propto 1 /$  distance from the conductor

### **Magnetic field due to current carrying circular loop:**

- The magnetic field can be represented by concentric circles at each point.
- The circles keep getting bigger as we move away from the wire.
- The magnetic field lines generated at each point of the current carrying wire appear as straight lines at the center of the loop.
- The direction of the magnetic field inside the loop is the same.

### **Factors affecting the magnetic field of a current carrying circular loop -**

- Magnetic field  $\propto$  The current flowing through the conductor.
- magnetic field  $\propto 1 /$  distance from the conductor.
- Number of turns of the magnetic field coil.

- The magnetic field is coordinated. The magnetic field of each turn adds up to the magnetic field of the other because the direction of the current is the same in each circular turn.

**Solenoid:** A cylindrical shaped coil of insulated copper wire wrapped side by side with many turns is called a solenoid.

- The magnetic field of a solenoid is similar to that of a bar magnet.
- The magnetic field inside the solenoid is uniform and is represented by parallel lines.

**Direction of magnetic field:**

- outside the solenoid - north to south
- inside the solenoid - south to north
- A solenoid is used to magnetize a magnetic material like soft iron.

**Table 9.1**

Electromagnet	Permanent Magnet
1. It is a temporary magnet, so it can be easily demagnetized.	1. Magnetism cannot be easily removed.
2. Its power can be changed.	2. Power is fixed.
3. Polarity can be changed.	3. Polarity cannot be changed.
4. are often more powerful	4. They are usually weak magnets

**Force on a current carrying conductor in a magnetic field**

Andre Marie Ampère proposed that a magnet also exerts a force equal in magnitude but opposite in direction to a current-carrying conductor.

The displacement in a conductor is maximum when the direction of current is perpendicular to the direction of the magnetic field. When the direction of current changes, the direction of force also changes.

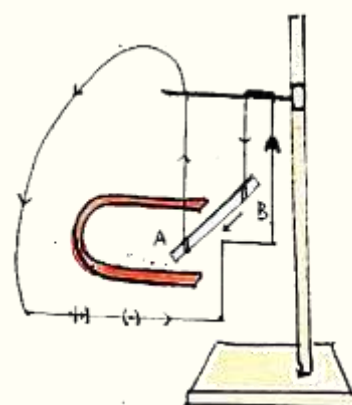

**Fleming's Left Hand Rule:** Extend your index, middle and thumb fingers in such a way that all three are perpendicular to each other. If the index finger points in the direction of the magnetic field and the middle finger in the direction of the current flowing in the conductor, then the thumb will point in the direction of motion or the direction of force in the conductor.

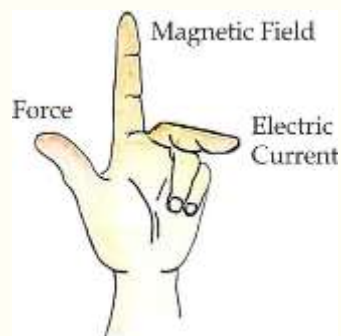

There is an important magnetic field in the heart and brain of the human body.

**MRI:** (Magnetic Resonance Imaging) Using magnetic resonance imaging, images of the internal organs of the body can be obtained.

- Galvanometer - A device that detects the presence of electric current in a circuit. It also indicates the direction of the current.
- Electromagnetic Induction - When a conductor is placed in a changing magnetic field, an electric current is induced in the conductor. This current is called induced current and this phenomenon is called electromagnetic induction.

#### Activity ( 1 ) :

- (1) When the magnet is brought towards the coil - momentary deflection in the galvanometer indicates the presence of electric current.

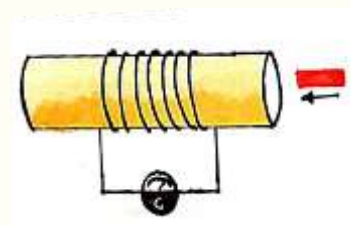

- (2) No deflection when the magnet is kept near the coil at rest.
- (3) When the magnet is moved away, there is a momentary deflection in the galvanometer. But it is opposite to before.

#### Activity ( 2 ) :

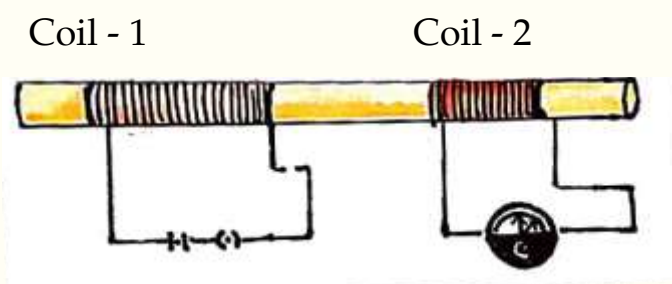

Primary Coil	Secondary Coil
1. The switch is turned on.	Momentary deflection in the galvanometer.
2. Direct current.	No distractions.
3. Switched off.	Momentary deflection in the galvanometer but in the opposite direction to before

### Fleming South (right) hand rule:

Extend the index, middle and thumb of your right hand in such a way that all three are perpendicular to each other. If the forefinger indicates the direction of the magnetic field and the thumb the direction of motion of the conductor, then the middle finger indicates the direction of the current induced in the conductor.

This rule - (1) Is the working principle of the generator.

(2) It is used to find the direction of the induced electric current.

**Alternating Current** - The electric current which changes its direction after equal time intervals.

reverses its direction after every  $\frac{1}{100}$  second.

$$\text{Time interval} = \frac{1}{100} + \frac{1}{100} = \frac{1}{50} \text{ second}$$

$$\text{Frequency} = \frac{1}{(\text{Time Interval})} = \frac{1}{1/50} = 50\text{Hz}$$

**Advantages** - AC can be transmitted over long distances without much energy loss.

**Disadvantage** - Alternating current cannot be stored.

### Direct current

- The electric current which does not change its direction is called direct current .
- Can store direct current.
- Energy is lost more in transmission over long distances.

Source - cell, battery, storage cell .

**Domestic Electric Circuit** – Three types of wires are used.

- (1) live wire (positive) red insulating cover
  - (2) neutral wire (negative) black insulating cover
  - (3) Ground wire - green insulating cover
- there is a potential difference of 220 V between the live wire and the neutral wire .
  - Pole - > Main Supply - > Fuse - > Electrometer - > Distribution Box -

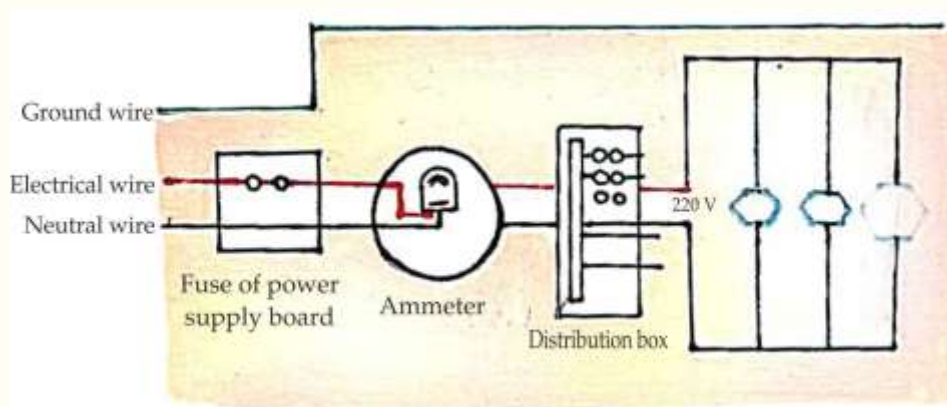

> Isolated Circuit

Fig . 9.9

**Ground Wire:** It protects us from electric shock if the current is eroded by the metallic cover of the appliance. It provides a low resistance path when the current dissipates.

**Short Circuit:** (Short Circuit): When suddenly both the live wire and the neutral wire come in direct contact, then a short circuit occurs.

## Practice Work

Q. 1. Select the correct option.

1. Similar magnetic poles repel each other.
  - a) Attracted
  - b) Repelled
  - c) Both A and B
  - d) None of these
2. Permanent magnets are made.
  - a) Copper
  - b) Soft iron
  - c) Steel
  - d) Brass
3. The SI unit of magnetic field is
  - a) Tesla
  - b) Ohm
  - c) Ampere
  - d) Volt

Q. 2. Fill in the blanks –

- (1) The direction of the force applied on the current carrying conductor is determined by the rule.
- (2) Electric fuse works on the basis of .....effect of electric current.
- (3) The rotating parts of an electric motor are called .....

Q. 3. State True/False -

1. Unlike poles of a magnet attract each other.
2. A freely suspended magnet stops in the north-south direction.
3. Electromagnets are temporary magnets.
4. Direct current can be stored.

Q. 4. Match the correct pair.

- | Column 'A'         | Column 'B'       |
|--------------------|------------------|
| 1. Electrical wire | Black            |
| 2. Neutral wire    | Green            |
| 3. Ground wire     | Red              |
| 4. Electromagnet   | Temporary magnet |

Q. 5. Very short answer type questions

1. The electric current which changes its direction after equal intervals of time

Q. 6. Short answer type questions -

1. What is earth wire?
2. What is short circuit?
3. What is the function of a galvanometer?
4. What is electromagnetic induction?

Q. 7. Long Answer Question -

1. With the help of labeled diagram explain the working of domestic electric circuit.
2. What is direct current? What is its source ?
3. What is Fleming's right hand rule?
4. Differentiate between an electromagnet and a permanent magnet.
5. Name any two protection devices used in electric circuits.
6. What precautions should be taken to avoid overloading in domestic electrical circuit.

Project work -

1. Verify the poles by hanging a bar magnet.

## Chapter - 10

### Sources of Energy

As you know, energy is required to do any work. Dear students! In this chapter, we will study about the different sources of this energy and the different forms of energy.

- Energy has different forms and one form of energy can be converted into another.
- A source of energy that conveniently provides a sufficient amount of energy over a long period of time.

स्तीर्णा अस्य संहतो विश्वरूपा घृतस्य योनौ स्रवथे मधूनाम् ।  
अस्थुरत्र धेनवाः पिन्वमाना मही दस्मस्य मातरा समीची ॥

(ऋग्वेद. 3.1.7)

Agni (energy) has been described as having many forms.

Agni (energy) -

ये अग्नयो अप्सव १ न्तर्ये वृत्रे ये पुरुषे ये अश्वसु ।  
य आविवेशोषधीर्यो वनस्पतीस्तेभ्यो अग्निभ्यो हुतमस्त्वेतत् ॥

(अथर्व. 3.21.1)

In this mantra of Atharvaveda, the energy of lightning that roars during rain, the energy located in water, the energy located in the body, the energy located in the sun, the energy located in the crops, the energy located in the trees have been mentioned.

यथानलः खेऽनिलबन्धुरुष्मा बलेन दारुण्यधिमथ्यमानः ।  
अणुः प्रजातो हविषा समेधते तथैव मे व्यक्तिरियं हि वाणी ॥

(श्रीमद्भागवत एकादश स्कन्ध अथ द्वादशोऽध्यायः 18)

Various forms of energy are mentioned in this verse of Shrimad Bhagwat. Agni (energy) is located in the sky in the form of heat or electricity. There is mention of energy being located in wood.

**Energy requirement**

- to make food



- to generate light
- for transportation
- to run the machines
- In industries and agriculture.

### **Characteristics of the best source of energy -**

- (1) do more work per unit mass ( higher calorific value)
- (2) Be cheap and easily accessible.
- (3) Be easy to store and transport.
- (4) Be easy and safe to use.
- (5) Do not pollute the environment.

### **Fuel -**

- (1) The substance which gives heat and light on burning is called fuel .

### **Properties of good fuel**

- (1) High calorific measurement
- (2) Do not generate excessive smoke or harmful gases.
- (3) Should have medium ignition temperature.
- (4) Be cheap and easily available.
- (5) Burn easily.
- (6) Be easy to store and transport.

### **Conventional sources of energy -**

Those sources of energy which are used by the general public for years are called conventional sources of energy . Example - fossil fuel biomass.

### **Fossil Fuel -**

- Fossil derived fuel. Example-Coal, petroleum, are called fossil fuels.
- Production in millions of years, limited storage, non-renewable resource.
- 6% of the world's coal reserves in the year, which will last for a maximum of 250 years if spent at the current rate.

## Pollution/damages caused by burning fossil fuels

- (1) Oxides of carbon, nitrogen and sulfur released from the burning of fossil fuels cause air pollution and acid rain, which affects water and soil resources.
- (2) The carbon dioxide produced produces the green house effect, due to which there is excessive heat on the earth.

## Measures to reduce pollution caused by fossil fuels -

1. By increasing the efficiency of the combustion process.
2. To reduce the escape of gases generated as a result of combustion into the atmosphere, by using various techniques.

म्रोको मनोहा खनो निर्दाह आत्मदूषिस्तनदूषिः । (अथर्व 16.1.3)

यो व आपोऽग्निराविवेश स एष यद् वो धोरं तदेतत् । (अथर्व 16.1.8)

The fire (energy) of the mines has been mentioned in the Atharvaveda. This energy is lethal (mroka), suffocating (manoha), scorching, burning (nirdah) and extremely fierce (ghor).

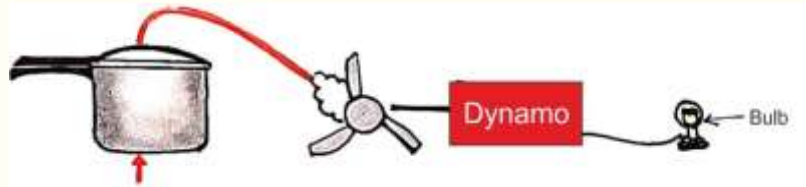

## Thermal Power Plant :

Figure – 10.1

- Thermal electricity is generated in thermal energy homes by burning fossil fuels.
- Thermal power plants are established near coal and oil fields, so as to reduce the cost of transportation.
- Electricity transmission is more efficient than coal and petroleum.

## Hydro power plant

- Hydroelectric power plants convert the potential energy of falling water into electrical energy.

- Hydroelectric power plants are associated with dams, because the number of water falls is very less.
- 25% of the energy demand is met by hydroelectric power plants.

वातस्य जूर्ति वरुणस्य नाभिमश्वं जज्ञानं, सरिरस्य मध्ये ।  
शिशुं नदीनां, हरिमद्रिबुधमग्ने मा हिंसीः परमे व्योमन् ॥

(यजु. 13.42)

There is mention of generating electricity from water.

#### Benefit -

- (1) No harm to the environment.
- (2) Hydroelectric energy is a renewable energy source.
- (3) By the construction of dams it is possible to stop flood and make irrigation possible.

#### Disadvantages -

- (1) Due to the construction of dams, agricultural land and human habitation are destroyed due to submergence.
- (2) Ecosystems get destroyed.
- (3) Generation of methane gas, which is a green house gas, by rotting in anaerobic conditions due to drowning of plants, vegetation in water.
- (4) The problem of satisfactory rehabilitation of the displaced people.

पुरीष्योसि विश्वभरा ऽ अथर्वा त्वा प्रथमो निरमन्थदग्ने ।  
त्वामग्ने पुष्करादध्यथर्वा निरमन्थत । मूर्ध्नो विश्वस्य वाघतः ॥

(यजु. 11.32)

Agni (energy) is all-pervasive and sustainer of the world. First of all there is mention of Atharva Rishi generating energy from Arani Manthan.

**Improvement in technology for utilization of conventional sources of energy**

1. Bio mass (bio mass)

Agricultural and animal waste that is used as fuel. For example - wood, cow dung, dry stems, leaves etc.

(1) **Wood** - Wood is a form of biomass, which has been used as a fuel for a long time.

**disadvantages -**

- Produces a lot of smoke when burnt.
- Do not give excess heat.

Therefore, the efficiency of conventional energy sources can be increased by improving the technology of equipment. Like making charcoal from wood.

**Charcoal:** When wood is burnt in a limited supply of air, water and volatile substances present in it are driven out and charcoal is obtained as a residue.

Wood    Limited amount of O<sub>2</sub>    Charcoal

**Charcoal is a better fuel than wood because -**

- Burns without flame.
- Relatively less smoke is released.
- The capacity to generate heat is high.

अरण्योर्निहितो जातवेदा गर्भ इव सुधितो गर्भिणीषु।  
दिवेदिव ईड्यो जागृवद्भिर्हविष्मद्भिर्मनुष्येभिरग्निः ॥

(ऋग. 3.29.2)

In the Rigveda, there is mention of the production of fire by the friction of Aranis. Agni (energy) is mentioned in the Samidhas of a tree named Arani.

**Dung cake** - a form of organic matter but there are many disadvantages in using it as fuel, such as-

- Produce a lot of smoke
- Ash formation due to incomplete combustion
- But with technical help, when cow dung is used in cow dung gas plant, it becomes a cheap and good fuel.

**Bio gas** - When cow dung, residue left after harvesting of crops, vegetable waste and excreta are decomposed in the absence of oxygen, bio gas is formed. As a result of decomposition, gases like methane, carbon dioxide, hydrogen and hydrogen sulphide are produced. The biogas is stored in a tank above the cover, which is piped out for use.

#### **Benefits of bio gas -**

- (1) Biogas is an excellent fuel, as it contains up to 75% methane gas.
- (2) Burns without producing smoke.
- (3) After burning, there is no residue left like ash like coal and wood.
- (4) High heating capacity.
- (5) Bio gas is used as a source of light.
- (6) Nitrogen and Phosphorus are abundant in the remaining slurry in the plant, which is used as an excellent fertilizer.
- (7) Safe way to make waste materials useful.

#### **wind power**

- Due to uneven heating of land and water bodies by solar radiations, air movement is generated and winds flow.
- The kinetic energy of the wind is used by windmills to do the following.
  - (a) Drawing water from wells
  - (b) Running grain mills
  - (c) To rotate the turbine so that electricity can be generated by the generator.
  - (d) But the output from a single wind mill is very less, so many wind mills are installed together and this place is called wind power farm.
- should be 5-20 km per hour to run windmill .

#### **Benefits of wind energy -**

1. Environment friendly

2. Best source of renewable energy
3. No recurring expenditure or cost in generating electrical energy.

#### Limitations of Wind Energy -

1. Huge land area requirement for wind power farm.
2. Continuous supply of 5-20 kmph wind speed.
3. High initial cost.
4. Management cost of wind mill blades is high.
  - Denmark is called the "Country of the Winds".
  - ranks 5th in generating electricity through wind energy .
  - India's largest wind power farm has been set up near Kanyakumari in Tamil Nadu which generates 380 MW of electricity.

#### Alternative / non-conventional energy sources:

With the advancement in technology the demand for energy is increasing day by day. Therefore, there is a need for alternative sources of energy.

#### Cause -

- (1) Fossil fuel is available in limited quantity. If we keep on using them at the present rate, they will be finished soon.
- (2) To reduce the dependence on fossil fuels so that they can last longer.
- (3) To save the environment and reduce the pollution rate.

#### solar energy

Sun is a major source of energy. The energy obtained from the sun is called solar energy.

अधुक्षत् पिप्युषीमिषमूर्जं सप्तपदीमरिः ।

सूर्यस्य सप्त रश्मिभिः ।

(ऋग्व. 8.72.16)

In the Rigveda, there is mention of seven types of energy (saptapadi) being obtained from the seven types of rays of the sun .

हस्काराद् विद्युत्स्पर्शतो जाता अवन्तु नः ।

## मरुतो मृळयन्तु नः ॥

(ऋग. 1.23.12)

In Rigveda, there is a description of the origin of electricity from light and there is an indication of the use of electricity in air-conducting instruments.

### Solar constant

The amount of solar energy that reaches the surface of the earth per square meter in one second is called the solar constant. Its value is  $1.4 \text{ KW/m}^2$ .

### Solar Energy Tips -

- |                        |   |  |
|------------------------|---|--|
| (1) Solar Cooker       | } | Collecting and using solar energy in the form of heat. |
| (2) Solar water heater |   |  |
| (3) Solar cell         | } | Converting solar energy into electricity.              |

### In solar heating devices -

- (1) Black surface absorbs more heat. That's why black color is used in these tips.
- (2) Mirrors and glass sheets are used to focus the sun rays, due to which greenhouse effect is generated and high temperature is generated.

**Box type solar cooker** - Take a box of heat-insulating material and paint black on the inner surface and walls. The box is covered with a glass sheet. The plane mirror is adjusted in such a way that maximum sunlight is reflected to create high temperature in the box.

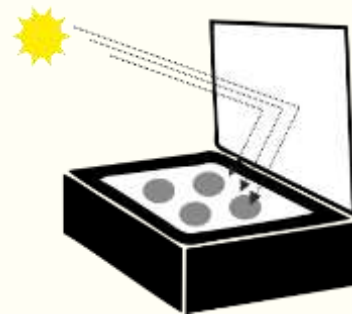

2-3 hours, the temperature inside the box reaches up to  $1000 \text{ C} - 1400 \text{ C}$ .

### Benefit -

- (1) Saving of fossil fuels like coal/petroleum .

- (2) Pollution does not spread.
- (3) Nutrients of food items are not destroyed.
- (4) More than one food can be prepared simultaneously.

#### disadvantages -

- (1) The solar cooker cannot be used at night.
- (2) It cannot be used during rains.
- (3) Continuous adjustment of sunlight is necessary so that it falls straight on its mirror .
- (4) Cannot be used for frying and baking.

#### solar cell

Solar cells convert solar energy directly into electricity.

- A typical solar cell gives 0.5 to IV which can generate about 0.7 W ( electric power).
- When a large number of solar cells are combined, the arrangement is called a solar panel.

<b>Solar Sail</b>	
<b>Advantages –</b>	<b>Disadvantages –</b>
1. There is no moving part.	1. Cost of production process.
2. Extremely low cost of operation and maintenance.	2. Limited availability of specific grades of silicon.
3. Works quite satisfactorily without any focusing device.	3. Silver used for interconnecting solar cells is very expensive.
4. Can be installed even in remote places.	
5. Environment friendly.	

#### Uses of solar cell

- (1) Use of solar cells in man made satellites.



- (2) Solar cell panels are used in radio and wireless communication devices, TV relay centers in remote areas.
- (3) Use of solar cell in traffic signals, calculator and many toys .

### **Geothermal energy -**

'Earth' means 'earth' and 'thermal' means 'heat'. The thermal energy present in the earth's core at the hot places of the earth is called geothermal energy. When underground water comes in contact with hot spots, steam is generated. When this steam gets trapped in between the rocks, its pressure increases. This language at high pressure is extracted through pipes which rotates the turbine and electricity is generated.

### **Benefit -**

- (1) The cost of power generation by this is not high.
- (2) There is no pollution.

### **Disadvantages -**

- (1) Geothermal energy is available only at limited places.
- (2) It is difficult and expensive to reach the depth of hot spots.

Several electric power plants based on geothermal energy are in operation in New Zealand and the United States.

### **Nuclear energy**

- The energy released during a nuclear reaction is called nuclear energy.
- This energy can be obtained by two types of reactions-
  - (1) Nuclear fission
  - (2) Nuclear fusion

### **Nuclear fission**

- Vikhandan means to break.
- Nuclear fission is the process in which the nuclei of heavy atoms (such as uranium, plutonium or thorium) are broken into lighter nuclei by bombardment with low energy neutrons.
- A huge amount of energy is released in this process.
- Uranium- 235 is used as fuel in nuclear reactors in the form of rods.

## Working style

In nuclear reactors, the nuclear fuel is part of a self-sustaining fission chain reaction, in which energy is released at a controlled rate. This free energy is used to generate electricity by making steam.

### Nuclear power plant

- (1) Tarapur ( Maharashtra)
- (2) Rana Pratap Sagar (Rajasthan)
- (3) Kalpakkam (Tamil Nadu)
- (4) Narora (Uttar Pradesh)
- (5) Kakrapar (Gujarat)
- (6) Kaiga (Karnataka)

### Nuclear fusion

A large amount of energy is released is called nuclear fusion.

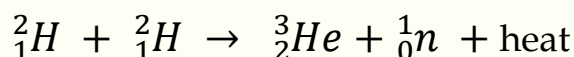

- Nuclear fusion requires extreme heat and pressure.
- Nuclear fusion is the source of enormous energy of the Sun and other stars.
- Hydrogen bomb is also based on 'nuclear fusion reaction'.

### Benefit -

- (1) The fission of a small amount of nuclear fuel releases a large amount of energy.
- (2) Green house gases like CO<sub>2</sub> are not produced.

### disadvantages -

- (1) There is a lot of cost in the installation of nuclear power plants.
- (2) The fear of leakage of nuclear radiation remains.
- (3) Risk of environmental pollution in the absence of proper storage and disposal of nuclear wastes.
- (4) Limited availability of uranium.

अमूर्या उप सूर्ये याभिर्वा सूर्यः सह।

ता नो हिन्वन्त्वध्वरम् ॥

(अथर्व. 1.4.2)

Atharvaveda mentions the presence of hydrogen element in the Sun.



## Practice Work

Q. 1. Select the correct option -

- (1) The energy obtained from the sun is called-
  - (a) Wind energy
  - (b) Solar energy
  - (c) Electric energy
  - (d) Nuclear energy
- (2) The fuel used in nuclear plants is -
  - (a) Uranium
  - (b) Coal
  - (c) Water
  - (d) Petrol
- (3) Wind mill converts wind energy into which energy?
  - (a) Solar energy
  - (b) Electrical energy
  - (c) Chemical energy
  - (d) Nuclear energy

Q. 2. Fill in the blanks –

- (1) The substance which produces light and heat on burning is called .....
- (2) Wind mill converts wind energy into ..... energy.
- (3) Solar cells convert solar energy into ..... energy.

Q. 3. Mark True (✓) or False (✗) against the following statements.

- (1) Isotopes of uranium are used as nuclear fuel.
- (2) Black surface absorbs more heat.
- (3) Coal is a fossil fuel.

Q. 4. Match the correct pair.

- | Column 'A'                            | Column 'B'     |
|---------------------------------------|----------------|
| (1) Conventional source of energy     | Nuclear energy |
| (2) Non-conventional source of energy | Fossil fuel    |
| (3) Nuclear fission reaction          | Hydrogen bomb  |
| (4) Nuclear fusion reaction           | Atomic bomb    |

Q. 5. Very short answer type questions -

- (1) In which energy does the hydroelectric power plant convert the potential energy of water?

- (2) Write the names of the fossil fuels.

**Q.6. Short Answer Type Questions -**

- (1) Draw a labeled diagram of a solar cooker and explain its working.
- (2) Explain its functioning by making a labeled diagram of a bio gas plant.
- (3) Write the characteristics of an ideal fuel.

**Q. 7. Long answer type questions -**

- (1) Draw a labeled diagram of a wind mill and explain its working.

**Project work**

- (1) Make a model of a wind mill.

## Chapter - 11

### Our environment

The word environment has been formed by combining two words Pari and Vapar, in which Pari means around us i.e. that which surrounds us and Vapar means circle. Environment is the aggregate unit of all those physical, chemical and biological factors that affect any living organism or ecological population and determine their form, life and survival.

द्वौ भूतसगौ लोकेऽस्मिन्दैव आसुर एव च ।

(गीता 16.6)

According to this verse of Shrimad Bhagwad Gita, there are two types of elements present in the world, divine elements (positive) and demonic elements (negative). The cover which is required for protection from negative elements is called environment or environment.

In Vedas, the environment has been defined by the names of Ulb, Vapar, Paridhi, Paribhu, Parivrit etc.

नासदासीन्नो सदासीत् तदानीं नासीद्रजो नो व्योमा परोयत् ।  
किमावरीवः कुह कस्य शर्मन्नम्भः किमासीद्गहनं गभीरम् ॥

(ऋग्वेद 10.129.1)

In this mantra of Rigveda's Nasadiya Sukta, it has been told that before the creation of the universe, there was neither Sat, nor Asat, nor the world, nor the sky, then who covered us.

Environment Day declared by the United Nations is celebrated to bring political and social awareness towards the environment at the global level. It began in 1972 with the World Environment Conference organized by the United Nations General Assembly from June 5 to June 6. The first World Environment Day was celebrated on 5 June 1973 .

The biotic components of the environment include all the living organisms and plants, from micro-organisms to insects, and all the biological activities and processes related to them, while the abiotic components of the environment include non-living elements and the



processes related to them, such as - Elements of mountains, rocks, rivers, air and climate etc.

तस्माद्वा एतस्मादाप्रत्मन आकाशः सम्भूतः । आकाशद्वायुः । वायोरग्निः । अग्नेरापः ।  
अद्भ्यः पृथिवी । पृथिव्या ओषधयः । ओषधीभ्योऽन्नम् । अन्ना त्पुरूषः ।

(तैत्तिरीय उपनिषद् 2.1.1)

In this mantra of Taittiriya Upanishad, various components of the environment like – sky, air, fire, water, earth (land), vegetation, creatures etc. have been mentioned. All these elements together make up the environment.

Our sages were very visionary. He was extremely conscious of protecting and balancing each and every component of the environment. Considering the natural balance as essential for the common man, he made it a religious act. The Shanti Mantra of Yajurveda prays for the purification of the environment.

द्यौः शान्तिरन्तरिक्षं, शान्तिः पृथिवी शान्तिरापः शान्तिरोषधयः शान्तिः ।

वनस्पतयः शान्तिर्विश्वे देवाः शान्तिर्ब्रह्म शान्तिः सर्वं, शान्तिः शान्तिरेव

शान्तिः सा मा शान्तिरेधि ॥

(यजुर्वेद 36.17)

May the sky, space, earth, water, medicines, plants, Vishvadev and Brahma all give peace to us. May there be peace all around. Means there should be purity, no disorder (pollution) should arise in anyone.

दृते दृहं, ह मा मित्रस्य मा चक्षुषा सर्वाणि भूतानि समीक्षन्ताम् ।

मित्रस्याहं चक्षुषा सर्वाणि भूतानि समीक्षे । मित्रस्य चक्षुषा समीक्षामहे ॥

(यजुर्वेद 36.18)

All living beings in the environment should behave friendly with each other.

Constituent elements of environment in Vedic literature –

In the Vedic literature, the following components of the environment have been mentioned –

- |          |                         |         |          |
|----------|-------------------------|---------|----------|
| 1. Sky   | 2. Air                  | 3. Fire | 4. Water |
| 5. Earth | 6. Medicine (Vegetable) | 7. Food | 8. Man   |

1. **Sky** – The first element of the environment is the sky. The sky is the cover of this creation.

### आकाशो ब्रह्म ।

(छा.उ.7.12.1)

In Chhandogya Upanishad, the sky has been called Brahma, in the sky all the celestial bodies like planets, satellites, stars etc. exist.

2. **Vayu** – Vayu originated from the sky. Air is made up of several gases in definite proportions.

वायुः प्राणो हृदयं विश्वमस्य पद्भ्यां पृथिवी ह्येष सर्वभूतान्तरात्मा ॥

(मुण्डोक उपनिषद् 2.1.4)

In Mundok Upanishad it is said that air is life. Modern science also believes in the same principle that life is possible only because of oxygen.

3. **Fire** - Energy is obtained from fire only. This is the third element of environment.

### ज्योतीरुपमयमग्निः

(बृहदा. 1.5.11)

Fire is in the form of Jyotiswaroop because Jyoti (light) is obtained from fire only.

4. **Water** – Water is the fourth element of the environment.

या आपो दिव्या उत वा स्रवन्ति खनित्रिमा उत वा याः स्वयंजाः ।

समुद्रार्था याः शुचयः पावकास्ता आपो देवीरिह मामवन्तु ॥

(ऋग. 7.49.2)

Various forms of water have been described in this Rigvedic mantra, such as rain water, river water, water extracted from the earth (underground water) etc.

5. **Earth (Land)** – The basic element of life is Earth.



एतस्माज्जायते प्राणो मनः सर्वेन्द्रियाणि च ।  
खं वायुर्ज्योतिरापः पृथिवी विश्वस्य धारिणी ॥

(मुण्डोक उपनिषद् 2.1.3)

The earth supports the whole world. All living beings are born from this.

शिलां भूमिरश्मा पांसुः सा भूमिः संघृता दृता ।  
तस्यै हिरण्यवक्षसे पृथिव्या अकरं नमः ॥

(अथर्व. 12.1.26)

In this Atharvavedic mantra, land has been described as having different colors like – black, brown, red and different forms of land like – boulders, pebbles, soft etc. have been mentioned.

महीनां पयोऽसि ।

(यजु. 4.3)

According to Shukla Yajurveda, there is water in the earth. It has been told so.

गिरयस्ते पर्वता हिमवन्तोऽरण्यं ते पृथिवी स्योनमस्तु ।

(अथर्ववेद 12.1.11)

In this mantra of Atharvaveda, it has been told that there are many high mountains and flat plains on the earth and there are snow covered ranges and forests.

यस्यां समुद्र उत सिन्धुरापो यस्यामन्नं कृष्टयः संवभुवः ।  
यस्यामिदं जिन्वति प्राणदेजत् सा नो भूमिः पूर्वपेये दधातु ॥

(अथर्ववेद 12.1.3)

It is mentioned in this mantra of Atharvaveda that there are seas, rivers, lakes and springs on earth. Food grains are produced on land. All living beings live happily on earth.

यस्यामन्नं व्रीहियवौ यस्या इमाः पञ्च कृष्टयः ।  
भूम्यै पर्जन्यपत्न्यै नमोऽस्तु वर्ष मेदसे ॥

(अथर्ववेद 12.1.42)



It is mentioned in this mantra of Atharvaveda that all the people have equal right on all the things produced on the earth. We salute the Mother Earth who nurtures all mankind.

6. **Medicine (Vanaspati)** – Medicine (Vanaspati) is an important component of the environment.

पञ्च राज्यानि वीरुधां सोमश्रेष्ठानि ब्रूमः ।  
दर्भी भङ्गो यवः सहस्ते नो मुञ्चन्त्वंहसः ॥

(अथर्व. 11.6.15)

Groups of medicines have been mentioned, such as – Som, Dabhra, Bhang, Yav and Sahas.

7. **Food** – Consumers take food as food.

ब्रीहयश्च मे यवाश्च मे माषाश्च मे तिलाश्च मे मुद्गाश्च मे खल्वाश्च मे प्रियङ्गवश्च मेणवश्च  
मे श्यामाकाश्च मे नीवाश्च मे गोधूमाश्च मे मसूराश्च मे यज्ञेन कल्पन्ताम् ॥

(यजु. 18.12)

In this Yajurvedic mantra, 12 types of food grains have been mentioned such as – Paddy, Barley, Urad, Sesame, Moong, Chana, Priyangu, Fine rice, Sowa, Tinni, Wheat and Masoor.

8. **Men** – From the point of view of the component of the environment, it comes under the category of consumer.

In general sense, it is a unit made up of all organic and non-organic elements, facts, processes and events affecting our lives. It pervades all around us and every event in our life depends on it and is edited. All the activities done by humans affect the environment directly and indirectly. Thus there is also a relationship between an organism and its environment, which is dependent on the other.

## Ecosystem

Definition - All the living and non-living components of an area together form an ecosystem. Hence an ecosystem consists of biotic (living organisms) and abiotic components. For example, it is made up of temperature, rain, air, soil etc.

त्रीणि च्छन्दांसि कवयो वि येतिरे पुरुरूपं दर्शतं विश्वचक्षणम्।  
आपो वाता ओषधयस्तान्येकस्मिभुवन आर्पितानि ॥

(अथर्व. 18.1.17)

In the Atharvaveda, water, air, vegetation (remedies) are mentioned as the main constituents of the environment.

### Importance of air

आ वात वाहि भेषजं वि वात वाहि यद् रूपः।  
त्वं हि विश्वभेषज देवानां दूत ईयसे ॥

(अथर्व. 4.13.3)

Describing the importance of air in the Atharvaveda, it is said that air has two qualities - firstly, through Prana Vayu, it transmits life force in human beings and through Apan Vayu, it removes all the diseases from the body. In this Atharvavedic mantra, Vayu has been called Vishvabheshaj, because Vayu destroys all diseases and defects.

**Types of ecosystem** - There are two types of it -

- (a) **Natural ecosystem** - ecosystem which exists in nature. Example - forest, ocean, lake.
- (b) **Man-made ecosystem** - The ecosystems which have been created by humans are called man-made ecosystems. Example - field, reservoir, garden.

### Abiotic components -

All non-living components, such as air, water, soil, light and temperature, etc. together form abiotic components.

### biological components

All the living components like plants, animals, micro-organisms, molds etc. together make up the organic components.

On the basis of food, the biological components are divided into the following -



1. **Producer** - All green plants, blue-green algae make their food (sugar and starch) from inorganic substances using sunlight. (Photosynthesis)
2. **Consumers** - such organisms which directly or indirectly depend on the producers for their sustenance .

**Consumers are divided into the following types –**

- (i) Herbivores - plant and leaf eaters. Like - goat, deer.
  - (ii) Non-vegetarian - Meat eaters. Like - lion, crocodile.
  - (iii) Omnivores - eaters of both plants and meat. Like - crow, man.
  - (iv) Parasite - living in the body of another organism and taking food. Like - lice, amarel.
3. **Decomposers** - molds and bacteria which decompose dead organisms and plants into simpler substances. These types of decomposers help in replenishing sources.

### Food chain

- A food chain is a chain in which one organism eats another organism as food  
Example - Grass → Deer → Lion
- Food chain, the biotic components through which energy is transferred are called trophic levels.
- Energy is transferred in one direction in a food chain.
- Green plants absorb 1% of the sun's energy that falls on the leaves .
- 10% rule - only 10% of the energy is transferred from one trophic level to another trophic level, while 90% of the energy is used in biological activities in the current trophic level.
- A very small amount of energy becomes available for the next level of consumer. Therefore, there are usually only three or four steps in the food chain.

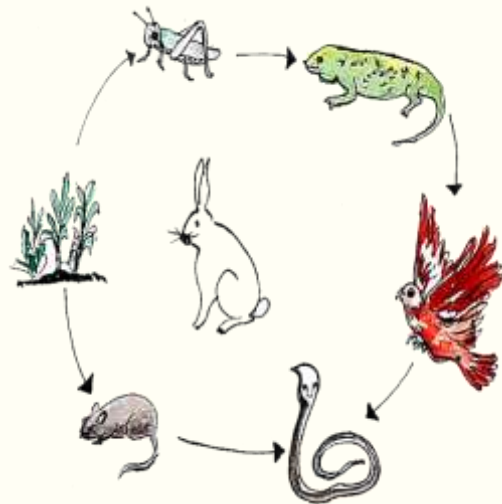

## Food Safety

अन्नपतेऽन्नस्य नो देहि । अनमीवस्य शुष्मिणः । प्र प्रदातारं तारिषः ।

ऊर्जं नो धेहि द्विपदे चतुष्पदे । अग्ने पृथिवीपते । सोम वीरुधां पते ।

त्वष्टः समिधां पते । विष्णवाशानां पते । मित्र सत्यानां पते ।

वरुण धर्मणां पते ।

(तैत्तिरीयब्राह्मणम् 1-4-11-3)

O provider of food, please give us nutritious and fragrant food. Give salvation to the provider of food. Provide energy to two legged and four legged people. O Agni, the lord of the earth, give us wholesome and fragrant food. O Som, lord of creepers and flowers, you give us wholesome and fragrant food. O Tvashta, the master of various samidhas, you give us nutritious and fragrant food. O Vishnu, Lord of the various directions, you give us nutritious and fragrant food. Lord of Truth, O Mitradev, you give us nutritious and fragrant food. Lord Varundev of Dharma, you give us nutritious and fragrant food.

In these mantras, a prayer has been made to provide nutritious, fragrant, energy-giving food to all the chief deities, the lord of the earth, Agni, Som (Moon), Tvashta, Vishnu, Mitradev, Varundev. The safety of food grains of the two-legged and four-legged creatures living on the earth depends on these deities.

## Bioculture

The amount of harmful chemicals increases as we move from one trophic level to another in the food chain. This is called bioculture.

The human body has the largest amount of such chemicals.

## Food web

Food chains are naturally connected with each other, which takes the form of a web, it is called a food web.

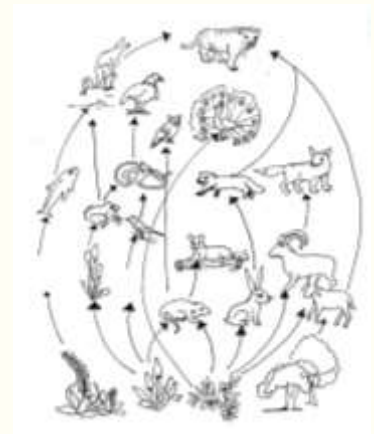

## Environmental problems

Changes in the environment affect us and our activities also affect the environment. This is



causing gradual degradation of the environment, causing environmental problems. For example, pollution, deforestation.

### Ozone layer -

The ozone layer is a protective layer around the Earth that absorbs harmful ultraviolet light from the Sun. In this way, the health related losses of the living beings ; For example, protects against skin cancer, cataract, weak immune system, damage to plants, etc.

The ozone layer is mainly found in the stratosphere, which is part of our atmosphere. Ozone at ground level is a deadly poison.

### Formation of Ozone

The formation of ozone is the result of the following photochemical reactions.

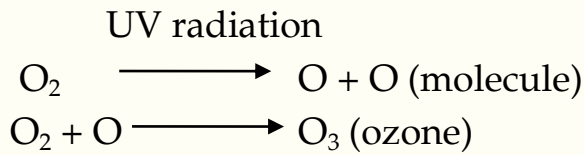

### Depletion of ozone layer

1985, a decrease in the thickness of the ozone layer was observed in Antarctica, which is known as the ozone hole.

The main factor in this rapid decline in the amount of ozone was considered to be the man-made chemical chlorofluorocarbons. Which are used for cooling and fire fighting.

1987, the United Nations Environment Program (UNEP) reached a consensus that CFC production should be limited to 1986 levels (Kyoto Protocol).

अध्वर्यवो यो दृभीकं जघान यो मा उदाजदप हि वलं वः ।  
तस्मा एतमन्तरिक्षे न वातमिन्द्रं सोमौरोर्णुत जूर्न वस्त्रैः ॥

(ऋग. 2.14.3)

It is mentioned in this mantra of Rigveda that the cover of the earth is like thick clouds, there should not be any hole in it. It is because of this cover that medicines, food etc. can be produced on the earth.

## Waste Management

In today's time, waste disposal is one of the main problems affecting our environment. Due to our lifestyle, a huge amount of garbage gets accumulated.

Methods of waste management -

- (a) Biomass Plant - Biodegradable material (waste) can be converted into biomass and manure by this plant.
- (b) Sewage treatment system – The drain water is modified by this system before going into the river.
- (c) Garbage landfills – Garbage is dumped in low lying areas and buried.
- (d) Composting - The organic waste is filled in the compost pit and covered (by soil) in three months the waste turns into manure.
- (e) Recycling – Non-biodegradable waste material is converted into new materials for reuse.
- (f) Reuse - This is a traditional way, in which you can use an item again and again. Example making envelopes from newspaper.

## Practice Work

Q. 1. Select the correct option -

- (1) Which of the following is a biotic component -  
(a) Air (b) Water  
(c) Soil (d) Plants
- (2) Environment Day is celebrated on -  
(a) 15<sup>th</sup> July (b) 12<sup>th</sup> July  
(c) 5<sup>th</sup> June (d) 1<sup>st</sup> December
- (3) Which of the following is a natural ecosystem -  
(a) Field (b) Well  
(c) Garden (d) Forest

Q. 2. Fill in the blanks –

- (1) The chemical that damages the ozone layer is .....
- (2) Storing rain water and using it is called.....
- (3) Green plants are called .....

Q. 3. Mark True (✓) or False (✗) against the following statements.

- (1) The ocean is the largest ecosystem.
- (2) Green plants come in the first trophic level.
- (3) Man comes under omnivores in the ecosystem.

Q. 4. Match the correct pair.

- | Column 'A'             | Column 'B'   |
|------------------------|--------------|
| (1) Productive         | Deer         |
| (2) Consumer           | Green plants |
| (3) Natural ecosystem  | Garden       |
| (4) Man-made ecosystem | Forest       |

Q. 5. Very short answer type questions

- (1) By which process do plants make their food?



Q. 6. Short Answer Type Questions -

- (1) What is called ecosystem? How many types of ecosystem are there ?
- (2) Into how many parts are the biological components divided on the basis of diet?
- (3) What is ozone layer?

Q. 7. Long answer type questions -

- (1) Explain the food chain pictorially.

**आदर्श प्रश्नपत्र / Model Que. Paper : V/23-24/ विज्ञान /**  
**वेदभूषण पञ्चम / वर्ष-Vedabhusan Fifth Year/**  
**कक्षा -10 वीं पूर्व मध्यमा /- II / Class 10<sup>th</sup> /Purv Madhyama - II**  
**वर्ष /Year 2023-24**  
**विषय विज्ञान –/Science**

पूर्णांक/M.M. – 100

समय/Time – 3 घण्टे

<ul style="list-style-type: none"><li>• सभी प्रश्न हल करना अनिवार्य हैं।</li><li>• सभी प्रश्न के उत्तर पेपर में यथास्थान पर ही लिखें।</li><li>• इस प्रश्न पत्र में कुल 38 प्रश्न हैं, प्रत्येक प्रश्न के सामने निर्धारित अंक दिये गये हैं।</li><li>• उत्तीर्णता हेतु न्यूनतम 40% अंक निर्धारित हैं।</li><li>• आदर्श प्रश्न पत्र का छात्रों को लिखित परीक्षा हेतु अभ्यास कराएँ।</li></ul>	<ul style="list-style-type: none"><li>• It is mandatory to attempt all the questions compulsorily.</li><li>• Write down the answers at the appropriate places provided.</li><li>• This question paper contains 38 questions. Marks for each question are shown on the side.</li><li>• The minimum pass marks are 40%.</li><li>• The model question paper should be used by the students for written examination practice.</li></ul>
--	---

सही विकल्प का चयन कीजिए / Choose the correct option -  $10 \times 2 = 20$

नोट – दिए गए प्रश्नों में आंतरिक विकल्पों (अ, ब, स, द) में से किसी एक का चयन करें –

Note – Select any one of the internal options (A, B, C, D) in the given questions -

1. इन्द्रधनुष का बनना प्रकाश की किस घटना का उदाहरण है –

The formation of a rainbow is an example of which phenomenon of light?

(i) अपवर्तन      (ii) परावर्तन      (iii) वर्ण विक्षेपण      (iv) प्रकीर्णन  
Refraction      Reflection      Dispersion      Scattering

(अ) केवल (i)      (ब) (i) और (ii)  
Only (i)      (i) and (ii)

(स) केवल (iii)      (द) (i),(ii),(iii) तीनों  
Only (iii)      (i), (ii), (iii) all the three



2. ग्रेफाइट का उपयोग किया जाता है –

Graphite is used for –

- |  |  |
|--|--|
| (i) स्नेहक के रूप में<br>As a lubricant      | (ii) पेन्सिल बनाने में<br>For making pencils |
| (iii) काँच को काटने में<br>For cutting glass | (iv) आभूषण बनाने में<br>For making ornaments |
| (अ) केवल (ii)<br>Only (ii)                   | (ब) (i) और (ii)<br>(i) and (ii)              |
| (स) (i) और (iii)<br>(i) and (iii)            | (द) केवल (iv)<br>Only (iv)                   |

3. कार्बन को ऑक्सीजन की उपस्थिति में गर्म करने पर कौन – सी गैस बनती है –

Which gas is formed when carbon is heated in the presence of oxygen –

- |                                   |  |
|-----------------------------------|--|
| (i) नाइट्रोजन<br>Nitrogen         | (ii) कार्बन डाइऑक्साइड<br>Carbon dioxide |
| (iii) हाइड्रोजन<br>Hydrogen       | (iv) हीलियम<br>Helium                    |
| (अ) केवल (iii)<br>Only (iii) only | (ब) केवल (ii)<br>Only (ii)               |
| (स) (i) और (iii)<br>(i) and (iii) | (द) केवल (iv)<br>Only (iv)               |

4. पृथिव्याः सधस्थार्ग्निं पुरीष्यमङ्गिरस्वत्वनामि ।

ज्योतिष्मन्तं त्वाग्ने सुप्रतीकमजस्रेण भानुना दीद्यतम्॥ (यजुर्वेद 11.28)

उपर्युक्त वेद मन्त्र में पुरीष्य अग्नि शब्द का उल्लेख किस गैस के लिए है –

For which gas is the word Purishya Agni mentioned in the above Veda Mantra?

- |                 |                    |
|-----------------|--------------------|
| (i) ऑक्सीजन गैस | (ii) हाइड्रोजन गैस |
|-----------------|--------------------|

	Oxygen gas		Hydrogen gas
(iii)	भूगर्भीय गैस	(iv)	नाइट्रोजन गैस
	Geothermal gas		Nitrogen gas
(अ)	केवल (ii)	(ब)	केवल (iv)
	Only (ii)		Only (iv)
(स)	केवल (iii)	(द)	(ii) और (iii)
	Only (iii)		(ii) and (iii)

5. फ्रियॉन गैस का उपयोग किया जाता है –

Freon gas is used for –

(i)	वाहनों में ईंधन के रूप में	(ii)	एयरकण्डीशनर में
	As fuel in vehicles		In air conditioners
(iii)	रेफ्रिजरेटर में	(iv)	भोजन बनाने के लिए ईंधन के रूप में
	In refrigerator		As fuel for cooking
(अ)	केवल (ii)	(ब)	केवल (iii)
	Only (ii)		Only (iii)
(स)	(i) और (iii)	(द)	(ii) और (iii)
	(i) and (iii)		(ii) and (iii)

6. निम्न में से पादप हार्मोन है –

Which of the following is a plant hormone –

(i)	ऑक्सीजन	(ii)	जिबरेलिन	(iii)	इंसुलिन	(iv)	थायरोक्सिन
	Oxygen		Gibberellin		Insulin		Thyroxine
(अ)	केवल (iii)	(ब)	केवल (iv)				
	Only (iii)		Only (iv)				
(स)	(i), (ii), (iii) तीनों	(द)	(i), (iii), (iv) तीनों				
	(i), (ii), (iii) all the three		(i), (iii), (iv) all the three				



7. पवन चक्की, पवन ऊर्जा को किस ऊर्जा में रूपांतरित करने का कार्य करती है –

Wind mill works to convert wind energy into which energy –

- |  |                                 |
|--|---------------------------------|
| (i) रासायनिक ऊर्जा<br>Chemical energy    | (ii) सौर ऊर्जा<br>Solar energy  |
| (iii) विद्युत ऊर्जा<br>Electrical energy | (iv) जलीय ऊर्जा<br>Hydro energy |
| (अ) केवल (i)<br>Only (i)                 | (ब) (i) और (ii)<br>(i) and (ii) |
| (स) केवल (iv)<br>Only (iv)               | (द) केवल (iii)<br>Only (iii)    |

8. या आपो दिव्या उत वा स्रवन्ति खनित्रिमा उत वा याः स्वयंजाः ।

समुद्रार्था याः शुचयः पावकास्ता आपो देवीरिह मामवन्तु ॥ (ऋग्वेद 7.49.2)

उपर्युक्त वेद मन्त्र में पर्यावरण के किस घटक के बारे में उल्लेख है –

Which component of the environment is mentioned in the above Veda Mantra?

- |                          |                                 |                            |                              |
|--------------------------|---------------------------------|----------------------------|------------------------------|
| (i) वायु<br>Air          | (ii) जल<br>Water                | (iii) अग्नि<br>Fire        | (iv) भूमि<br>Land            |
| (अ) केवल (i)<br>Only (i) | (ब) (i) और (ii)<br>(i) and (ii) | (स) केवल (iv)<br>Only (iv) | (द) केवल (iii)<br>Only (iii) |

9. कथन (A) – बॉक्सरूपी सौर कुकर के आंतरिक धरातल तथा दीवारों पर काला रङ्ग का पेन्ट करते हैं ।

Assertion (A): The inner surface and walls of the box-shaped solar cooker are painted black.

कथन (R) – काला रङ्ग ऊष्मा का अच्छा अवशोषक होता है –

Reason (R) – Black color is a good absorber of heat –

- (अ) A एवं R दोनों सही हैं। R, A की सही व्याख्या करता है।  
Both A and R are correct. R is the correct explanation of A.
- (ब) A एवं R दोनों सही हैं। R, A की सही व्याख्या नहीं करता है।  
Both A and R are correct. R does not explain A correctly.
- (स) A सही है परन्तु R गलत है।  
A is correct but R is incorrect.
- (द) A गलत है परन्तु R सही है।  
A is wrong but R is correct.

10. कथन (A) ताँबा एवं एलुमिनियम के तारों का उपयोग विद्युत सञ्चरण के लिए किया जाता है –  
Assertion (A) Copper and aluminum wires are used for electricity transmission –

कथन (R) ताँबा एवं एलुमिनियम विद्युत के कुचालक होते हैं।

Reason (R) Copper and aluminum are bad conductors of electricity.

- (अ) A एवं R दोनों सही हैं। R, A की सही व्याख्या करता है।  
Both A and R are correct. R is the correct explanation of A.
- (ब) A एवं R दोनों सही हैं। R, A की सही व्याख्या नहीं करता है।  
Both A and R are correct. R does not explain A correctly.
- (स) A सही है परन्तु R गलत है।  
A is correct but R is incorrect.
- (द) A गलत है परन्तु R सही है।  
A is wrong but R is correct.

रिक्त स्थानों की पूर्ति कीजिए / Fill in the blanks –

$$5 \times 1 = 5$$

11. .... ऊर्जा के कारण वृक्ष वनस्पतियों में भोजन बनाने की क्रिया सम्पन्न होती है।

The process of making food in trees and plants is accomplished due to ..... energy.

12. वस्तु का बड़ा प्रतिबिम्ब देखने के लिए ..... दर्पण का उपयोग किया जाता है।

To see the enlarged image of the object..... mirror is used.



13. प्रकाश की ..... घटना के कारण आकाश का रङ्ग नीला दिखाई देता है ।  
The color of the sky appears blue due to the phenomenon of light.
14. .... धातु में सबसे कम जङ्ग लगती है ।  
Rusting is least in ..... metal.
15. .... तन्त्रिका तन्त्र की संरचनात्मक एवं क्रियात्मक इकाई है ।  
..... is the structural and functional unit of the nervous system.
16. निम्नलिखित युग्मों पर विचार कीजिए – 5 x 0.5 = 2.5

Consider the following pairs –

स्तम्भ क	स्तम्भ ख
Column A	Column B
कॉलम क	कॉलम ख
(i) धातु Metal	(अ) लेंस Lens
(ii) अधातु Non-metal	(ब) लोहा Iron
(iii) प्राकृतिक पारितन्त्र Natural ecosystem	(स) सल्फर Sulfur
(iv) मानव निर्मित पारितन्त्र Man-made ecosystem	(द) वन Forest
(v) स्वपोषी पोषण Autotrophic nutrition	(य) उद्यान Garden
	(र) पौधे Plants

उपर्युक्त युग्मों के आधार पर सही विकल्प का चयन कीजिए –

Select the correct option based on the above pairs –

- (अ) (i) (स), (ii) (अ), (iii) (र), (iv) (य), (v) (द)

(ब) (i) (ब), (ii) (र), (iii) (य), (iv) (अ), (v) (स)

(स) (i) (ब), (ii) (स), (iii) (द), (iv) (य), (v) (र)

(द) (i) (ब), (ii) (अ), (iii) (र), (iv) (स), (v) (य)

17. निम्नलिखित युग्मों पर विचार कीजिए –

5 x 0.5 = 2.5

Consider the following pairs –

स्तम्भ क Column A	स्तम्भ ख Column B
(i) आमाशय Stomach	(अ) वृद्धि हार्मोन Growth hormone
(ii) यकृत Liver	(ब) हाइड्रोक्लोरिक अम्ल Hydrochloric acid
(iii) पीयूष ग्रंथी Pituitary gland	(स) पित्त रस Bile juice
(iv) नाभिकीय विखण्डन अभिक्रिया Nuclear fission reaction	(द) हाइड्रोजन का बनना Formation of hydrogen
(v) नाभिकीय सलयन अभिक्रिया Nuclear fusion reaction	(य) परमाणु बम Atomic bomb
	(र) लिङ्ग हार्मोन Sex hormones

उपर्युक्त युग्मों के आधार पर सही विकल्प का चयन कीजिए –

Select the correct option based on the above pairs –

(अ) (i) (ब), (ii) (स), (iii) (अ), (iv) (य), (v) (द)

(ब) (i) (ब), (ii) (र), (iii) (य), (iv) (अ), (v) (स)

(स) (i) (स), (ii) (अ), (iii) (र), (iv) (य), (v) (द)

(द) (i) (ब), (ii) (अ), (iii) (र), (iv) (स), (v) (य)

18. निम्नलिखित कथनों पर विचार कीजिए –

5 x 0.5 = 2.5

Consider the following statements –

(i) L.P.G. का उपयोग घरों में भोजन बनाने के लिए ईंधन के रूप में किया जाता है ।





L.P.G. It is used as fuel for cooking food in homes.

- (ii) इन्द्रधनुष सदैव पूर्व दिशा में बनता है ।

The rainbow is always formed in the east direction.

- (iii) हीरा विद्युत का सुचालक है ।

Diamond is a good conductor of electricity.

- (iv) एथेन, असंतृप्त हाइड्रोकार्बन है ।

Ethane is an unsaturated hydrocarbon.

- (v) तेल एवं वसायुक्त भोजन लम्बे समय तक रखने पर दुर्गन्धयुक्त हो जाता है ।

Oily and fatty food gets foul when kept for a long time.

उपर्युक्त (i से v तक) कथनों में से कौन – से सही है ?

Which of the statements given above (i to v) are correct?

- (अ) i और iii (ब) i, iii, iv

i and iii i, iii, iv

- (स) i और v (द) ii, iii, v

i and v ii, iii, v

19. निम्नलिखित कथनों पर विचार कीजिए –

5 x 0.5 = 2.5

Consider the following statements –

- (i) विद्युत धारा का S.I. मात्रक एम्पीयर है ।

S.I. unit of electric current is ampere.

- (ii) शुद्ध जल विद्युत का कुचालक होता है ।

Pure water is a poor conductor of electricity.

- (iii) चुम्बक के असमान ध्रुव एक दूसरे को प्रतिकर्षित करते हैं ।

Unlike poles of a magnet repel each other.

- (iv) जीवाश्म ईंधन ऊर्जा का पारंपरिक स्रोत है ।

Fossil fuel is a traditional source of energy.

- (v) रात के समय सौर कुकर का उपयोग भोजन बनाने में किया जा सकता है ।

Solar cooker can be used to cook food at night.



उपर्युक्त (i से v तक) कथनों में से कौन – से सही है ?

Which of the statements given above (i to v) are correct?

- (अ) i और iii                      (ब) i, iii, iv  
i and iii                              i, iii, iv  
(स) ii और iv                      (द) ii, iii, v  
ii and iv                              ii, iii, v

अति लघूत्तरीय प्रश्न (पूर्ण पक्ति में उत्तर लिखना है)

5 x 2 = 10

Very Short Answer Type Questions (Answer to be written in full line)

20. अवतल दर्पण का क्या उपयोग है ?

What is the use of concave mirror?

-----  
-----  
-----  
-----

21. पर्यावरण के 5 संघटक तत्वों के नाम लिखिए ।

Write the names of 5 constituent elements of the environment.

-----  
-----  
-----  
-----

22. किन्ही दो जीवाश्म ईंधनों के नाम लिखिए ।

Write the names of any two fossil fuels.

-----  
-----  
-----

23. सौर सेल का एक उपयोग लिखिए ।

Write one use of solar cell.

-----  
-----



24. आयोडीन की कमी से होने वाले रोग का क्या नाम है ?

What is the name of the disease caused by iodine deficiency?

लघूत्तरीय प्रश्न

5 x 3 = 15

Short Answer Type Questions

25. सौर ऊर्जा किसे कहते हैं ? किस युक्ति के उपयोग के द्वारा सौर ऊर्जा को विद्युत ऊर्जा में रूपांतरित किया जा सकता है ? सौर ऊर्जा से संबद्ध वेद मन्त्र या श्लोक लिखिए ।

What is solar energy? By using which device solar energy can be converted into electrical energy? Write Veda mantra or shloka related to solar energy.

मन्त्र या श्लोक

26. धातु संक्षारण क्या है ? धातुओं के संक्षारण संबद्ध श्लोक लिखिए ।

What is metal corrosion? Write a shloka related to corrosion of metals.



मन्त्र या श्लोक

27. पारितन्त्र किसे कहते हैं ? पारितन्त्र से संबद्ध वेद मन्त्र श्लोक लिखिए ।

What is ecosystem? Write Veda Mantra Shloka related to ecosystem.

मन्त्र या श्लोक

28. 10 वोल्ट विभवांतर के दो बिन्दुओं के बीच 3 कुलांब आवेश को ले जाने में कितना कार्य किया जाता है ?

How much work is done in moving 3 coulomb charge between two points of 10 volt potential difference?

29. विद्युत चुम्बक एवं स्थायी चुम्बक में 3 अन्तर लिखिए ।

Write 3 differences between electromagnet and permanent magnet.



-----  
-----  
-----  
-----  
-----  
-----

विवरणात्मक प्रश्न

5 x 4 = 20

Descriptive Questions

30. मानव नेत्र की कार्यप्रणाली को सचित्र समझाइए ।

Explain the working of human eye with diagram.

चित्र/Diagram

व्याख्या/Explanation

-----  
-----  
-----  
-----  
-----  
-----  
-----  
-----  
-----  
-----

31. वैदिक वाङ्मय के संदर्भ में पर्यावरण के संघटक तत्वों को समझाइए ।

Explain the constituent elements of environment in the context of Vedic literature.

32. पौधों के भोजन निर्माण की क्रिया को समझाइए एवं संबद्ध वेद मन्त्र लिखिए ।

Explain the process of making food of plants and write the associated Veda Mantra.

मन्त्र या श्लोक

33. प्रकाश के अपवर्तन की घटना को उदाहरण सहित समझाइए।

Explain the phenomenon of refraction of light with examples.



---

---

---

---

---

---

---

---

34. आहार शृंखला को सचित्र समझाइए ।

Explain the food chain with diagram.

चित्र/Diagram

व्याख्या/Explanation

---

---

---

---

---

---

---

---

---

---

---

---

---

---

---

---

---

---

---

---

---

दीर्घ उत्तरीय प्रश्न

4 x 5 = 20

Long Answer Type Questions

35. मानव मस्तिष्क की क्रियाविधि को सचित्र समझाइए ।

Explain the working of human brain with diagram.



चित्र/Diagram

व्याख्या/Explanation

-----

-----

-----

-----

-----

-----

-----

-----

-----

-----

-----

-----

-----

-----

-----

-----

36. हार्मोन क्या है ? अंतःस्रावी ग्रंथियों से स्रावित होने वाले हार्मोन के नाम एवं उनके कार्य लिखिए।

What is hormone? Name the hormones secreted by the endocrine glands and write their functions.

-----

-----

-----

-----

-----





37. पूर्ण आंतरिक परावर्तन किसे कहते हैं ? उदाहरण सहित समझाइए ।

What is total internal reflection? Explain with examples.

38. नामांकित आरेख खींचकर घरेलू विद्युत परिपथ की क्रियाविधि को समझाइए ।

Explain the working of domestic electric circuit by drawing a labeled diagram.

चित्र/Diagram



व्याख्या/Explanation

-----

-----

-----

-----

-----

-----

-----

-----

-----

-----

-----

-----

-----

-----

-----

-----

-----

-----

-----

-----

-----

-----

-----

**Rashtriya Adarsh Veda Vidyalaya Run and Proposed by  
MAHARSHI SANDIPANI RASHTRIYA VEDA VIDYA PRATISHTHAN, UJJAIN (M.P.)**  
(Ministry of Education, Government of India)



**MAHARSHI SANDIPANI RASHTRIYA VEDA VIDYA PRATISHTHAN, UJJAIN (M.P.)**

(Ministry of Education, Government of India)

Veda Vidya Marg, Chintaman, Jawasiya, Ujjain, Madhya Pradesh 456006  
Phone : (0734) 2502266, 2502254, E-mail : msrvvpujn@gmail.com, website - www.msrvvp.ac.in